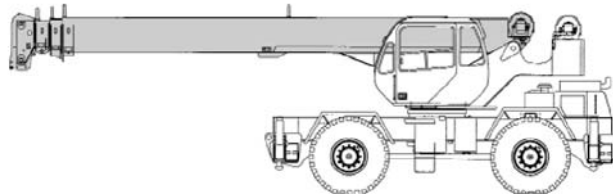

Rough Terrain Crane Specifications | RT200/200XL

STANDARD BOOM EQUIPMENT
BOOM

30-94' (9.23-28.78 m), four section full power boom. Telescoping is mechanically synchronized with single lever control. The synchronization system consists of a single telescope cylinder and high strength leaf chains to extend and retract the third section and tip section. Boom is high strength four plate design, welded inside and out, with anti-friction slide pads. Boom side plates are made with stamped impressions to reduce weight and increase strength. A single boom hoist cylinder provides for boom elevation of -4 to 76 degrees. All cylinders are equipped with integral hold valves. Maximum tip height is 99' (30.17 m).

BOOM HEAD

Welded to outer section of boom. Four or five metallic load sheaves and two idler sheaves mounted on heavy duty, anti-friction bearings. Quick reeving boom head. Provisions made for side-stow jib mounting.

OPTIONAL BOOM EQUIPMENT
MAIN BOOM

30-72' (9.23-22.19 m) three section full power boom **OR** 30-100' (9.23-30.61 m) four section full power XL Series boom.

Telescoping is mechanically synchronized with single lever control. The synchronization system consists of a single telescope cylinder and high strength leaf chains to extend and retract the tip section. Either boom is high strength four plate design, welded inside and out, with anti-friction slide pads. Boom side plates are made with stamped impressions to reduce weight and increase strength. A single boom hoist cylinder provides for boom elevation of -4 to 76 degrees. All cylinders are equipped with integral hold valves. Maximum tip height is 72' (22.19 m) boom options 79' (24.23 m). Maximum tip height with 100' (30.61 m) XL Series boom option is 107' (32.76 m)

AUXILIARY BOOM HEAD

Removable auxiliary boom head has single metallic sheave mounted on an anti-friction bearing. Removable pin-type rope guard for quick reeving. Installs on main boom peak only. Removal is not required for jib use.

HOOK BLOCK

Two, three or four metallic sheaves on anti-friction bearings with hook and hook latch. Quick reeving design does not require removal of wedge and socket from rope.

HOOK & BALL

7 ton (6.3 mt) top swivel ball with hook and hook latch

JIBS

26' (7.92 m) side stow swing-on one-piece lattice type jib. Single metallic sheave mounted on anti-friction bearing. Jib is offsettable at 0°, 15° or 30°. With 100' (30.61 m) XL Series boom, maximum tip height is 130' (39.62 m). 26-43' (7.92-13.11 m) side stow swing-on lattice type jib. Single sheave mounted on anti-friction bearing. Jib is extendible to 43' (13.11 m) by means of 17' (5.18 m) manual pull-out tip section, roller supported for ease of extension. Jib is offsettable at 0°, 15° or 30°. With 100' (30.61 m) XL Series boom, maximum tip height is 147' (44.80 m).



TEREX

ROUGH TERRAIN CRANE RT200/200XL

STANDARD UPPERSTRUCTURE EQUIPMENT

UPPERSTRUCTURE FRAME

All welded one-piece structure fabricated with high tensile strength alloy steel. Counterweight is bolted to frame.

TURNTABLE CONNECTION

Swing bearing is a single row, ball type, with external teeth. The swing bearing is bolted to the revolving upperstructure and welded to the carrier frame.

SWING

A hydraulic motor drives a double planetary reduction gear for precise and smooth swing function. Swing speed (no load) is 3.0 rpm.

SWING BRAKE

Heavy duty multiple disc swing brake is mechanically actuated from operator's cab by foot pedal. Brake may be locked on or used as a momentary brake. A separate 360° mechanical house lock is also provided.

RATED CAPACITY INDICATOR

Rated Capacity Indicator with visual and audible warning system and automatic function disconnects. Second generation pictographic display includes: boom radius, boom angle, boom length, allowable load, actual load, and percentage of allowable load registered by bar graph. Operator settable alarms provided for swing angle, boom length, boom angle, tip height, and work area exclusion zone. Anti-two block system includes audio/visual warning and automatic function disconnects.

OPERATORS CAB

Environmental cab with all steel construction, optimized visibility, tinted safety glass throughout, and rubber floor matting is mounted on vibration absorbing pads. The cab has a sliding door on the left side, framed sliding window on the right side, hinged tinted all glass skylight and removable front windshield to provide optimized visibility of the load open or closed. Acoustical foam padding insulates against sound and weather. The deluxe six-way adjustable operator's seat is equipped with a mechanical suspension and includes head and arm rests

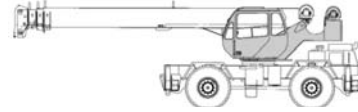

CONTROLS

All control levers and pedals are positioned for efficient operation. Hand operated control levers include swing, telescope, boom hoist, winch(s), shift, vernier adjustable hand throttle and 360° house lock. Switches include ignition, engine stop, two speed winch(s), lights, horn, windshield wipers, defroster, steering mode, parking brake, and outrigger controls. Foot control pedals include swing brake, boom raise, boom lower, service brakes and accelerator.

INSTRUMENTATION AND ACCESSORIES

In-cab gauges include air pressure, bubble level, engine oil pressure, fuel, engine temperature, voltmeter, transmission temperature, and transmission oil pressure. Indicators include low air, high water temperature/ low oil pressure/high transmission temperature audio/visual warning, low coolant audio/visual warning, hoist drum rotation indicator(s), and Rated Capacity Indicator. accessories include fire extinguisher; light package including headlights, tail lights, dome light, brake lights, directional signals, four-way hazard flashers, dome light, and back up lights with audio pulsating back-up alarm; windshield washer/ wiper and skylight wiper, R.H. and L.H. rear view mirrors; dash lights; and seat belt. Circuit breakers protect electrical circuits.

HYDRAULIC CONTROL VALVES

Valves are mounted on the upperstructure and are easily accessible. Valves are mechanically operated and include one four spool valve for boom elevation, telescope, main winch boost, and main winch; one single spool valve for swing. High pressure regeneration feature provides 2-speed boom extension. Quick disconnects are provided for ease of installation of pressure check gauges.

OPTIONAL EQUIPMENT

Auxiliary Winch, Heater/Defroster, Air Conditioner, Work Lights, Revolving Amber Light, Independent Rear Wheel Steering, Roof Mounted Spotlight.

STANDARD CARRIER EQUIPMENT

CARRIER CHASSIS

High strength chassis with four-wheel drive and four-wheel steer (4x4x4). Has box beam type construction with reinforcing cross members, a precision machined turntable mounting plate and integrally welded outrigger boxes. Decking has skid-resistant surfaces, including tool storage compartment, and access steps and handles left and right side and front and rear corners.

AXLES AND SUSPENSION

Rear axle is a planetary drive/steer type with 10.0" (0.25 m) of total oscillation. Automatic oscillation lockouts engage when the superstructure is swung 10° in either direction. An oscillation lock out override is provided. Front axle is a planetary drive/steer type, rigid mounted to the frame for increased stability.

WHEELS & TIRES

Disc type wheels with full tapered bead seat rim. 134" (3.40 m) wheelbase.

TIRES

Standard: 20.5 x 25,24 P.R. / Optional: 16.00 x 25, 28 P.R.

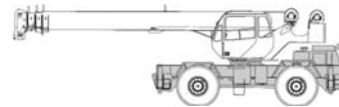

SERVICE BRAKES

Air over hydraulic drum type brakes on all four wheels: 17" x 4" (43.18 x 10.2 cm) drum brakes

PARKING BRAKE

Transmission mounted spring-set, air released external caliper disk type emergency/parking brake.

STEERING

Hydraulic four-wheel power steering for two-wheel, four-wheel, or crab steer is easily controlled by steering wheel. A rear axle centering light is provided.

STANDARD CARRIER EQUIPMENT (CONTINUED)

Turning radius to center of outside tire.	(16.00 x 25)	(20.5 x 25)
Two-wheel:	34' 8.81" (10.5 m)	34' 10.38" (10.63)
Four-wheel:	19' 3.44 (5.88 m)	19' 5" (5.92 m)

TRANSMISSION

Range-shift type power-shift transmission with integral torque converter has neutral safety start, 6 speeds forward, and 6 speeds reverse. Automatic pulsating back-up alarm.

MULTI-POSITION OUT & DOWN OUTRIGGERS

Fully independent hydraulic outriggers may be utilized fully extended, in their 1/2 extended position, or fully retracted. Easily removable steel floats, each with an area of 254² (1 639 cm²) stow on the carrier frame. Complete controls and sight leveling bubble are located in the operators' cab.

OPTIONAL EQUIPMENT

Cold Weather Starting Aid, Immersion Heater, Pintle Hook, Clearance Lights, Front Mounted Winch - 20,000 lb (9 072 kg), Independent Rear or Four Mode Rear Wheel Steer.

HYDRAULIC SYSTEM

HYDRAULIC PUMPS

Three gear type pumps, one single and two in tandem, driven off the transmission. Combined system capability is 113 gpm (427.7 lpm). Includes manual pump disconnect.

- ▶ **Main Winch Pump**
- ▶ 53 gpm (200.7 lpm) @ 3,500 psi (246.1 kg/cm²)
- ▶ **Boom Hoist and Telescope Pump**
- ▶ 39 gpm (147.6 lpm) @ 3,500 psi (246.1 kg/cm²)
- ▶ **Power Steering, Outrigger and Winch Boost Pump**
- ▶ 21 gpm (79.5 lpm) @ 2,500 psi (175 kg/cm²) Always live even when pump disconnect is actuated.

FILTRATION

Full flow oil filtration system with bypass protection includes a removable 60 mesh (250 micron) suction screen-type filter and 5 micron replaceable return line filter.

HYDRAULIC RESERVOIR

All steel, welded construction with internal baffles and diffuser. Provides easy access to filters and is equipped with an external sight level gauge. The hydraulic tank is pressurized to aid in keeping out contaminants and in reducing potential pump cavitation. Capacity is 94 gal (355 liters). Swing-away hydraulic oil cooler is standard

MAIN WINCH SPECIFICATIONS

Hydraulic winch with bent axis piston motor and planetary reduction provides 2-speed operation with equal speeds for power up and down. Winch is equipped with an integral automatic brake, a grooved drum with tapered flanges for improved rope spooling, a spring loaded cable roller and an electronic drum rotation indicator.

Performance	LO-Range	HI-Range
▶ Max line speed (no load)		
▶ First layer	205 fpm (62.5 m/min)	329 fpm (100.3 m/min.)
▶ Fifth layer	297 fpm (90.5 m/min)	475 fpm (144.8 m/min.)
▶ Max. line pull-first layer	12,512 lb (5 675 kg)	7,298 lb (3 310 kg)
▶ Max. line pull-fifth layer	8,662 lb (3 929 kg)	5,052 lb (2 292 kg)
▶ Permissible line pull	9,000 lb (4 082 kg)	

Drum Dimensions	Drum Capacity
▶ 10.62" (270 mm) drum diameter	Max. Storage: 598' (182.3 m)
▶ 17.53" (445 mm) length	6th layer is not a working layer
▶ 18.25" (464 mm) flange dia.	Max. useable: 479' (146.0 m)*
▶ Cable: 5/8" x 450' (16 mm x 137.2 m)	
▶ Cable type: 5/8" (16 mm) 6x19 IWRC IPS right regular lay, preformed.	
▶ Min. breaking strength 17.9 tons (16.2 mt)	

*Based on minimum flange height above top layer to comply with ANSI B30.5

OPTIONAL AUXILIARY WINCH

Hydraulic winch with bent axis piston motor, power up and down, equal speed, planetary reduction with integral automatic brake, cable roller, and rotation indicator.

Performance	(Same as main winch)
Drum Dimensions and Capacity	(Same as main winch)

OPTIONAL HOIST LINE

Main winch and optional auxiliary winch: 5/8" (16 mm) rotation resistant compacted strand 18 x 19 or 19 x 19. Min. breaking strength 22.6 tons (20.6 mt).

ENGINE SPECIFICATIONS

Make and Model	Standard Cummins 6BTA5.9
Type	6 Cylinder
Bore and Stroke	4.02x4.72" (102x120 mm)
Displacement	359 cu in (5.9 L)
Max. Gross HP	130 hp (97 kw)@2500 rpm
Max. Gross Torque	384 lb•ft (521 N•m) @1200 rpm
Aspiration	Turbocharged
Air Filter	Dry Type
Electrical System	12 volt
Alternator	102 amp
Battery	(2) 12V-1600 C.C.A.
Fuel Capacity	50 gal (189 L)

PERFORMANCE (STANDARD ENGINE)

Transmission Range	Gear	Forward Drive	Max. Speed	Max. Tractive Effort	Gradeability @ Stall
Low	1	4-Wheel	2.3 mph	37,856 lb	112.34%
			3.7 km/h	17 171 kg	
			4.4 mph	19,254 lb	39.84%
	2	4-Wheel	7.1 km/h	8 734 kg	
			12.4 mph	6,431 lb	11.10%
			20.0 km/h	2 917 kg	
High	1	2-Wheel	5.0 mph	16,893 lb	34.04%
			8.0 km/h	7 663 kg	
			9.5 mph	8,589 lb	15.59%
	2	2-Wheel	15.3 km/hr	3 896 kg	
			24.5 mph	2,849 lb	3.77%
			39.4 km/h	1 292 kg	

All performance data is based on a gross vehicle weight of 52,000 lb (23 583 kg). 16:00 x 25 tires, 4x4 drive. Performance may vary due to engine performance. Gradeability data is theoretical and is limited by tire slip, machine stability, or engine oil pan design.



GENERAL DIMENSIONS

1. Dimensions given assume the boom is fully retracted in travel position and 16:00 x 25 tires.
20.5 tires reduce heights 1.0 (25 mm)

2. Minimum ground clearance under transmission - 20.62" (.52m)
axle bowls - 19.12" (.49 m)
tire rods - 20.38" (.52 m)

3. Track width: 6' 7.50" (2.02 m) 16:00 x 25 tires
6' 10.5" (2.10 m) 20.5 x 25 tires

4. Width of carrier: 8' (2.44 m) 16:00 x 25 tires
8' 8" (2.64 m) 20.5 x 25 tires

Tire to frame angle	16:00 tires	20.5 tires
Approach angle:	25.1°	24.1°
Departure angle:	23.1°	22.2°

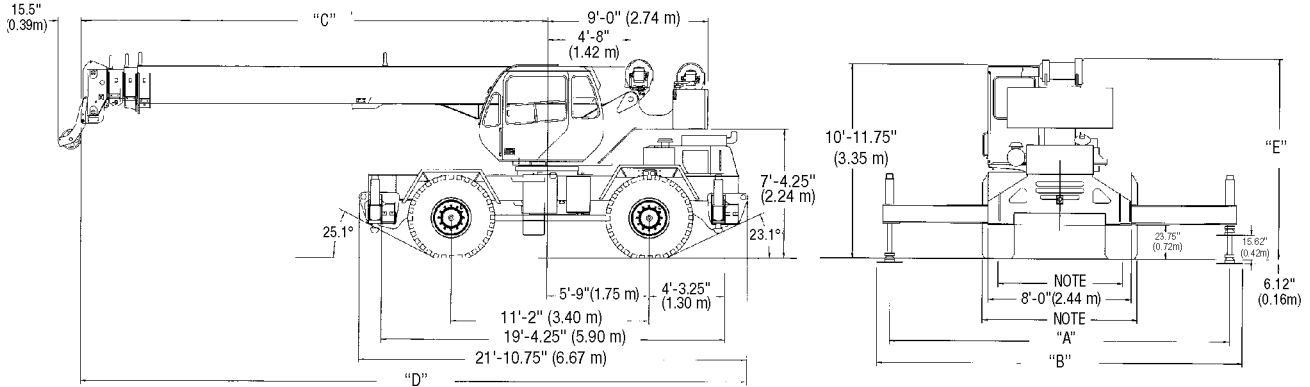

	"A"	"B"	Boom Length	"C"	"D"	"E"
Fully extended outriggers	19'-0" (5.79m)	20'-6" (6.25m)	32' (9.75m) Boom	15'-10" (4.83m)	27'-1" (8.25m)	12'-9.38" (3.90m)
Pinned outriggers	13'-2" (4.01m)	14'-8" (4.47m)	72' (22.19m) Boom	26'-4" (8.03m)	37'-7" (11.46m)	11'-7.5" (3.54m)
Fully retracted outriggers	7'-4.5" (2.25m)	8'-10.5" (2.71 m)	94' (28.78m) Boom	26'-4" (8.03m)	37'-7" (11.46m)	11'-7.5" (3.54m)
			100' (30.61m) Boom	28'-4" (8.64m)	39'-7" (12.06m)	11'-7.5" (3.54m)

WEIGHTS & AXLE LOADS	GROSS WEIGHT LB	UPPER FACING FRONT		GROSS WEIGHT KG	UPPER FACING FRONT	
		FRONT	REAR		FRONT	REAR
Basic Crane with 10,000 lb (4 536 kg) Counterweight	55,930	28,972	26,958	25 369	13 141	12 228
Add Options:						
26' (7.92 m) Swing-on Jib (Stowed)	+ 1100	+ 2,000	- 900	+ 499	+ 907	- 408
26'-43' (7.92-13.11 m) Swing-on Jib (Stowed)	+ 1500	+ 2,600	- 1,100	+ 680	+ 1 179	- 499
Auxiliary Boom Head	+ 100	+ 300	- 200	+ 45	+ 136	- 91
Auxiliary Winch with Wire Rope, Controls, Etc.	+ 115	- 25	+ 140	+ 52	- 11	+ 63
30 ton (27.2 mt) 4 Sheave Hook Block	+ 655	+ 1,071	- 416	+ 297	+ 486	- 189
30 ton (27.2 mt) 3 Sheave Hook Block	+ 670	+ 1,099	- 429	+ 304	+ 498	- 194
25 ton (22.6 mt) 2 Sheave Hook Block	+ 682	+ 1,117	- 435	+ 309	+ 507	- 198
7 ton (6.3 mt) Hook and Ball (in tool box)	+ 240	+ 290	- 50	+ 109	+ 130	- 21
Pintle Hook: Front	+ 45	+ 60	- 15	+ 20	+ 27	- 7
Rear	+ 45	- 25	+ 70	+ 20	- 11	+ 31
Substitute:						
72' (22.19 m) Full Power 3-Section Boom	- 3190	- 4,335	+ 1,145	- 1 445	- 1 965	+ 520
100' (30.61 m) Full Power 4-Section Boom	+ 533	+ 1,986	- 1,453	+ 242	+ 901	- 659
16:00 x 25 Tires	- 360	- 180	- 180	- 164	- 82	- 82

Note: Weights are for Terex supplied equipment and are subject to 2% variation due to manufacturing tolerances.

TEREX Cranes
106-12th Street S.E.
Waverly, Iowa 50677-9466 USA

TEL (319) 352-3920 FAX (319) 352-5727
EMAIL inquire@terexwaverly.com
WEB terex.com

WE RESERVE THE RIGHT TO AMEND THESE SPECIFICATIONS AT ANY TIME WITHOUT NOTICE. THE ONLY WARRANTY APPLICABLE IS OUR STANDARD WRITTEN WARRANTY APPLICABLE TO THE PARTICULAR PRODUCT AND SALE. WE MAKE NO OTHER WARRANTY, EXPRESSED OR IMPLIED.



Range Diagram and Lifting Capacity | RT230

30 TON LIFTING CAPACITY

RANGE DIAGRAM 30' - 94' BOOM

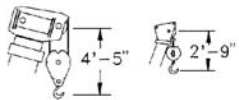

Dimensions are for largest factory furnished hook block and hook & ball, with anti-two block activated

COUNTER WEIGHT	W/AUX. WINCH 8,900 LB W/O AUX. WINCH 10,000 LB
BOOM LENGTH	30'-94'
OUTRIGGER SPREAD	19'
STABILITY PERCENTAGE	ON OUTRIGGERS 85% ON TIRES 75%
PCSA CLASS	10-118

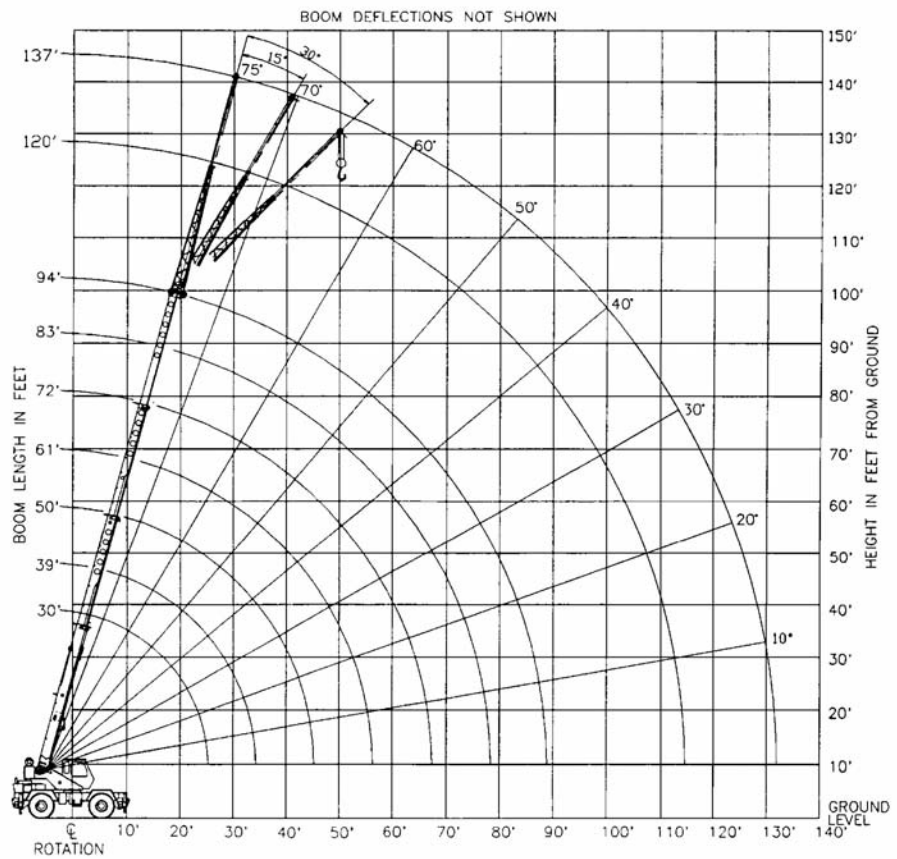

CRANE WORKING CONDITIONS

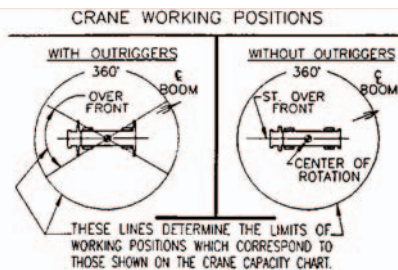

REDUCTION IN MAIN BOOM CAPACITY

All jib in stowed position	0 lb
ax. boom in head sheave	100lb

HOOK BLOCK WEIGHTS

Hook and ball	240 lb
Hook block (2 sheave)	680 lb
Hook block (3 sheave)	670 lb
Hook block (4 sheave)	653 lb



LIFTING CAPACITIES **CAUTION:** Do not use this specification sheet as a load rating chart. The format of data is not consistent with the machine chart and may be subject to change

ON OUTRIGGERS - FULLY EXTENDED

LOAD RADIUS (FT)	BOOM LENGTH 30'			BOOM LENGTH 39'			BOOM LENGTH 50'			LOAD RADIUS (FT)
	LOADED BOOM ANGLE (DEG)	OVER FRONT (LB)	360° (LB)	LOADED BOOM ANGLE (DEG)	OVER FRONT (LB)	360° (LB)	LOADED BOOM ANGLE (DEG)	OVER FRONT (LB)	360° (LB)	
10	63.0	60,000*	60,000*	69.4	46,600*	46,600*				10
12	58.5	50,100*	50,100*	55.2	46,600*	46,600*	71.7	44,500*	44,500*	12
15	51.4	40,100*	40,100*	61.2	40,000*	40,000*	68.0	38,500*	38,500*	15
20	37.4	30,100*	30,100*	52.3	30,000*	30,000*	61.6	30,000*	30,000*	20
25	13.7	22,800*	22,900*	42.0	23,600*	23,600*	54.8	24,000*	24,000*	25
30	**			28.8	18,600*	18,600	47.3	19,100*	19,100*	30
35				**			38.7	15,500	15,100	35
40							27.9	12,100	11,800	40
45							7.9	9,600	9,300	45
50							**			50
55										55
60										60
65										65
70										70
75										75
80										80
85										85

USE THESE CHARTS ONLY WHEN ALL OUTRIGGERS ARE FULLY EXTENDED

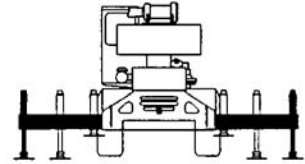



LIFTING CAPACITIES **CAUTION:** Do not use this specification sheet as a load rating chart. The format of data is not consistent with the machine chart and may be subject to change

ON OUTRIGGERS - FULLY EXTENDED

LOAD RADIUS (FT)	BOOM LENGTH 61'			BOOM LENGTH 72'			BOOM LENGTH 83'			BOOM LENGTH 94'			LOAD RADIUS (FT)
	LOADED BOOM ANGLE (DEG)	OVER FRONT (LB)	360° (LB)	LOADED BOOM ANGLE (DEG)	OVER FRONT (LB)	360° (LB)	LOADED BOOM ANGLE (DEG)	OVER FRONT (LB)	360° (LB)	LOADED BOOM ANGLE (DEG)	OVER FRONT (LB)	360° (LB)	
10													10
12													12
15	72.1	36,000*	36,000*										15
20	67.1	29,500*	29,500*	70.8	27,400*	27,400*							20
25	61.9	24,000*	24,000*	66.5	23,100*	23,100*	69.8	19,000*	19,000*	72.2	15,300*	15,300*	25
30	56.3	19,400*	19,400*	62.0	19,600*	19,600*	66.0	15,900*	15,900*	69.0	13,100*	13,100*	30
35	50.4	15,700	15,400	57.4	15,900	15,500	62.2	13,800*	13,800*	65.7	11,400*	11,400*	35
40	43.9	12,400	12,100	52.5	12,600	12,300	58.1	12,000*	12,000*	62.2	10,000*	10,000*	40
45	36.5	10,000	9,800	47.2	10,200	9,900	53.9	10,300	10,000	58.7	8,800*	8,800*	45
50	27.3	8,200	7,900	41.4	8,400	8,100	49.5	8,500	8,300	55.1	7,900*	7,900*	50
55	13.0	6,700	6,500	34.8	7,000	6,800	44.7	7,100	6,900	51.2	7,100*	7,000	55
60	**			26.9	5,800	5,600	39.5	6,000	5,800	47.2	6,100	5,800	60
65				15.5	4,800	4,600	33.6	5,000	4,800	42.8	5,100	4,900	65
70				**			26.6	4,200	4,100	38.0	4,300	4,200	70
75							17.0	3,500	3,400	32.7	3,700	3,500	75
80							**			26.4	3,100	2,900	80
85										18.1	2,600	2,400	85

****MAXIMUM CAPACITY AT 0 DEGREE BOOM ANGLE**

BOOM LENGTH 30'			BOOM LENGTH 39'			BOOM LENGTH 50'			BOOM LENGTH 61'			BOOM LENGTH 72'			BOOM LENGTH 83'			BOOM LENGTH 94'		
LOAD RADIUS (FT)	OVER FRONT (LB)	360° (LB)	LOAD RADIUS (FT)	OVER FRONT (LB)	360° (LB)	LOAD RADIUS (FT)	OVER FRONT (LB)	360° (LB)	LOAD RADIUS (FT)	OVER FRONT (LB)	360° (LB)	LOAD RADIUS (FT)	OVER FRONT (LB)	360° (LB)	LOAD RADIUS (FT)	OVER FRONT (LB)	360° (LB)	LOAD RADIUS (FT)	OVER FRONT (LB)	360° (LB)
25.6	21,900	21,900	34.3	15,200	14,900	45.3	9,400	9,100	56.3	6,300	6,100	67.3	4,400	4,200	78.3	3,100	2,900	89.3	2,100	2,000

LIFTING CAPACITIES CAUTION: Do not use this specification sheet as a load rating chart. The format of data is not consistent with the machine chart and may be subject to change

ON OUTRIGGERS - MID POSITION

LOAD RADIUS (FT)	BOOM LENGTH 30'		BOOM LENGTH 39'		BOOM LENGTH 50'		BOOM LENGTH 61'		BOOM LENGTH 72'		BOOM LENGTH 83'		BOOM LENGTH 94'		LOAD RADIUS (FT)
	LOADED BOOM ANGLE (DEG.)	360° (LB)	LOADED BOOM ANGLE (DEG.)	360° (LB)	LOADED BOOM ANGLE (DEG.)	360° (LB)	LOADED BOOM ANGLE (DEG.)	360° (LB)	LOADED BOOM ANGLE (DEG.)	360° (LB)	LOADED BOOM ANGLE (DEG.)	360° (LB)	LOADED BOOM ANGLE (DEG.)	360° (LB)	
10	63.0	60,000*	69.4	46,600*											10
12	58.5	50,100*	66.2	46,600*	71.7	44,500*									12
15	51.4	38,000	61.2	38,700	68.0	38,500*	72.1	36,000*							15
20	37.4	21,500	52.3	22,300	61.6	22,700	67.1	23,000	70.8	23,100					20
25	13.7	13,800	42.0	14,700	54.8	15,200	61.9	15,400	66.5	15,600	69.8	15,700	72.2	15,300*	25
30	**		28.8	10,300	47.3	10,900	56.3	11,100	62.0	11,200	66.0	11,400	69.0	11,400	30
35			**		38.7	8,000	50.4	8,300	57.4	8,400	62.2	8,500	65.7	8,600	35
40					27.9	5,900	43.9	6,300	52.5	6,500	58.1	6,600	62.2	6,600	40
45					7.9	4,400	36.5	4,800	47.2	5,000	53.9	5,100	58.7	5,200	45
50					**		27.3	3,600	41.4	3,800	49.5	4,000	55.1	4,100	50
55							13.0	2,600	34.8	2,900	44.7	3,100	51.2	3,200	55
60							**		26.9	2,100	39.5	2,300	47.2	2,400	60
65									15.5	1,500	33.6	1,700	42.8	1,800	65
70											26.6	1,100	38.0	1,300	70

****MAXIMUM CAPACITY AT 0 DEGREE BOOM ANGLE**

BOOM LENGTH 30'		BOOM LENGTH 39'		BOOM LENGTH 50'		BOOM LENGTH 61'		BOOM LENGTH 72'		BOOM LENGTH 83'		BOOM LENGTH 94'	
LOAD RADIUS (FT)	360° (LB)	LOAD RADIUS (FT)	360° (LB)	LOAD RADIUS (FT)	360° (LB)	LOAD RADIUS (FT)	360° (LB)	LOAD RADIUS (FT)	360° (LB)	LOAD RADIUS (FT)	360° (LB)	LOAD RADIUS (FT)	360° (LB)
25.6	12,900	34.3	7,600	45.3	4,200	56.3	2,400	67.3	1,200				

USE THESE CHARTS ONLY WHEN ALL OUTRIGGERS ARE PINNED IN MID POSITION

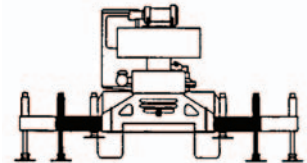



LIFTING CAPACITIES CAUTION: Do not use this specification sheet as a load rating chart. The format of data is not consistent with the machine chart and may be subject to change

ON OUTRIGGERS - RETRACTED

LOAD RADIUS (FT)	BOOM LENGTH 30'		BOOM LENGTH 39'		BOOM LENGTH 50'		BOOM LENGTH 61'		BOOM LENGTH 72'		BOOM LENGTH 83'		BOOM LENGTH 94'		LOAD RADIUS (FT)
	LOADED BOOM ANGLE (DEG.)	360° (LB)	LOADED BOOM ANGLE (DEG.)	360° (LB)	LOADED BOOM ANGLE (DEG.)	360° (LB)	LOADED BOOM ANGLE (DEG.)	360° (LB)	LOADED BOOM ANGLE (DEG.)	360° (LB)	LOADED BOOM ANGLE (DEG.)	360° (LB)	LOADED BOOM ANGLE (DEG.)	360° (LB)	
10	63.0	32,800	69.4	33,400											10
12	58.5	23,600	66.2	24,200	71.7	24,600									12
15	51.4	15,800	61.2	16,500	68.0	16,900	72.1	17,100							15
20	37.4	9,100	52.3	9,800	61.6	10,300	67.1	10,500	70.8	10,600					20
25	13.7	5,300	42.0	6,200	54.8	6,700	61.9	6,900	66.5	7,100	69.8	7,200	72.2	7,200	25
30	**		28.8	3,900	47.3	4,400	56.3	4,700	62.0	4,900	66.0	5,000	69.0	5,100	30
35			**		38.7	2,900	50.4	3,200	57.4	3,400	62.2	3,500	65.7	3,600	35
40					27.9	1,700	43.9	2,100	52.5	2,300	58.1	2,400	62.2	2,500	40
45							36.5	1,200	47.2	1,400	53.9	1,500	58.7	1,600	45
50											49.5	900	55.1	1,000	50

****MAXIMUM CAPACITY AT 0 DEGREE BOOM ANGLE**

BOOM LENGTH 30'		BOOM LENGTH 39'		BOOM LENGTH 50'		BOOM LENGTH 61'		BOOM LENGTH 72'		BOOM LENGTH 83'		BOOM LENGTH 94'	
LOAD RADIUS (FT)	360° (LB)	LOAD RADIUS (FT)	360° (LB)	LOAD RADIUS (FT)	360° (LB)	LOAD RADIUS (FT)	360° (LB)	LOAD RADIUS (FT)	360° (LB)	LOAD RADIUS (FT)	360° (LB)	LOAD RADIUS (FT)	360° (LB)
25.6	4,900	34.3	2,400										

USE THESE CHARTS WHEN ALL OUTRIGGER BEAMS ARE NOT IN EITHER THE MID OR FULLY EXTENDED POSITION

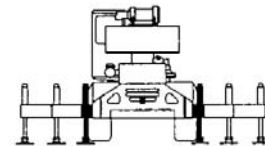



LIFTING CAPACITIES CAUTION: Do not use this specification sheet as a load rating chart. The format of data is not consistent with the machine chart and may be subject to change.

SIDE STOW JIB ON FULLY EXTENDED OUTRIGGERS

LOADED BOOM ANGLE (DEG)	26' OFFSETTABLE JIB/NO PULL OUT INSTALLED						43' OFFSETTABLE JIB/PULL OUT RETRACTED						LOADED BOOM ANGLE (DEG)
	0° OFFSET		15° OFFSET		30° OFFSET		0° OFFSET		15° OFFSET		30° OFFSET		
	LOAD RADIUS (REF) (FT)	360° (LB)	LOAD RADIUS (REF) (FT)	360° (LB)	LOAD RADIUS (REF) (FT)	360° (LB)	LOAD RADIUS (REF) (FT)	360° (LB)	LOAD RADIUS (REF) (FT)	360° (LB)	LOAD RADIUS (REF) (FT)	360° (LB)	
75	35	9,100	40	7,400	45	5,600	41	5,100	50	3,400	62	2,700	75
73	39	8,600	43	6,800	49	5,300	45	4,800	54	3,300	65	2,700	73
71	43	8,100	47	6,300	52	5,000	49	4,500	58	3,200	68	2,600	71
68	49	7,300	52	5,600	56	4,500	54	4,100	64	3,000	72	2,500	68
65	60	5,500	62	4,600	61	4,100	60	3,800	70	2,900	77	2,500	65
62	60	5,500	62	4,600	66	3,700	67	3,600	74	2,800	82	2,400	62
59	64	4,800	67	4,100	71	3,400	75	3,400	81	2,700	88	2,400	59
55	70	4,100	73	3,600	78	3,000	82	3,100	89	2,600	95	2,300	55
51	76	3,500	79	3,200	84	2,800	88	2,900	96	2,500	100	2,300	51
47	82	2,800	86	2,600	89	2,500	95	2,500	101	2,100	105	2,000	47
43	87	2,300	91	2,200	93	2,300	101	2,100	107	1,700	110	1,600	43
38	93	1,800	97	1,800	98	1,800	108	1,700	113	1,300	115	1,300	38
32	100	1,400	102	1,400	104	1,400	116	1,200	119	1,000	121	1,000	32
25	106	1,000	108	1,000	108	1,000							25

Notes For Jib Capacities:

- A. For all boom lengths less than the maximum with a jib erected, the rated loads are determined by boom angle only in the appropriate column.
- B. For boom angle not shown, use the capacity of the next lower boom angle.
- C. Listed radii are for extended main boom only.



LIFTING CAPACITIES

CAUTION: Do not use this specification sheet as a load rating chart. The format of data is not consistent with the machine chart and may be subject to change

ON TIRES

RADIUS (FT)	MAX BOOM LENGTH (FT)	16:00 X 25-28 PR				20:50 X 25-24 PR			
		PICK & CARRY				PICK & CARRY			
		STATIONARY		CREEP	2.5 MPH	STATIONARY		CREEP	2.5 MPH
		360°	STRAIGHT OVER FRONT			360°	STRAIGHT OVER FRONT		
10	30	23,600	45,900	36,100	26,500	24,000	44,200	34,700	23,700
12	30	17,300	39,700	31,100	22,600	19,000	35,300	29,900	20,200
15	39	13,000	27,400	25,400	18,200	14,100	27,400	24,400	16,100
20	39	8,000	16,200	16,200	13,200	8,400	16,600	16,600	11,500
25	50	5,200	11,000	11,000	9,700	5,400	11,200	11,200	8,300
30	50	3,200	7,900	7,900	7,500	3,400	8,100	8,100	6,300
35	50	1,900	6,100	6,100	6,000	2,000	6,100	6,100	5,000
40	61	1,200	4,900	4,900	4,800	1,300	4,900	4,900	3,900
45	61		3,800	3,800	3,800		3,900	3,900	3,100
50	61		2,700	2,700	2,700		2,800	2,800	2,400
55	61		2,000	2,000	2,000		2,100	2,100	1,800
60	72		1,500	1,500	1,500		1,500	1,500	1,300
65	72		1,100	1,100	1,100		1,200	1,200	900

Notes For On Tire Capacities:

- A. For Pick and Carry operations, boom must be centered over the front of the crane with swing brake and lock engaged. Use minimum boom point height and keep load close to ground surface.
- B. The load should be restrained from swinging. NO ON TIRE OPERATION WITH JIB ERECTED.
- C. Without outriggers, never maneuver the boom beyond listed load radii for applicable tires to ensure stability.
- D. Creep speed is crane movement of less than 200' (61 m) in a 30 minute period and not exceeding 1.0 mph (1.6 km/h).
- E. Refer to General Notes for additional information.

RECOMMENDED TIRE PRESSURE

TIRE SIZE	STATIONARY	CREEP	2 1/2 MPH	TRAVEL
16:00 x 25-28 PR	115 PSI	115 PSI	95 PSI	95 PSI
20:50 x 25-24 PR	95 PSI	95 PSI	70 PSI	70 PSI

MAXIMUM PERMISSIBLE HOIST LINE LOAD

LINE PARTS	1	2	3	4	5	6	7
MAX LOAD	9,080	18,160	27,240	36,320	45,400	54,480	63,560
BOOM HEAD	2	3-D	2-3	1-4-D	2-3-4	2-3-4-D	1-2-3-4
HOOK BLOCK	D	3	3-D	1-4	2-3-D	2-3-4	2-3-4-D
WIRE ROPE:	5/8" ROTATION RESISTANT 18X19 OR 19X19 MINIMUM BREAKING STRENGTH - 22.7 TONS 5/8" 6X19 OR 6X37 IWRC IPS PREFORMED RIGHT REGULAR LAY MINIMUM BREAKING STRENGTH - 17.9 TONS						



TEREX

General Notes | RT200

GENERAL

1. Rated loads as shown on Lift Charts pertain to this machine as originally manufactured and equipped. Modifications to the machine or use of optional equipment or other than that specified can result in a reduction of capacity.
2. Construction equipment can be hazardous if improperly operated or maintained. Operation and maintenance of this machine shall be in compliance with the information in the Operator's, Parts and Safety Manuals supplied with this machine. If These manuals are missing, order replacements from the manufacturer through your distributor.
3. These warnings do not constitute all of the operating conditions for the crane. The operator and job site supervision must read the OPERATORS MANUAL, CIMA SAFETY MANUAL, APPLICABLE OSHA REGULATIONS, AND SOCIETY OF MECHANICAL ENGINEERS (ASME) SAFETY STANDINGS FOR CRANES.
4. This crane and its load ratings are in accordance with POWER CRANE & SHOVEL ASSOCIATION, STANDARD NO.4 SAE CRANE LOAD STABILITY TEST CODE J765A, SAE METHOD OF TEST FOR CRANE STRUCTURE J1063 AND APPLICABLE SAFETY CODE FOR CRANES, DERRICKS AND HOISTS, ASME/ANSI B30.5

DEFINITIONS

1. **LOAD RADIUS** - The horizontal distance from the axis of rotation before loading to the center of the vertical hoist line or tackle with a load applied.
2. **LOADED BOOM ANGLE** - It is the angle between the boom base section and the horizontal, after lifting the rated load at the rated radius. The boom angle before loading should be greater to account for deflections. The loaded boom angle combined with boom length give only an approximation of the operating radius.
3. **WORKING AREA** - Areas measured in a circular arc about the centerline of rotation as shown in the diagram.
4. **FREELY SUSPENDED LOAD** - Load hanging free with no direct external force applied except by the hoist rope.
5. **SIDE LOAD** - Horizontal force applied to the lifted load either on the ground or in the air.
6. **NO LOAD STABILITY LIMIT** - The stability limit radius shown on the range diagrams is the radius beyond which it is not permitted to position the boom, when the boom angle is less than the minimum shown on the applicable load chart, because the machine can overturn without any load.
7. **BOOM SIDE OF CRANE** - The side of the crane over which the boom is positioned when in OVER SIDE working position.

SET-UP

1. Crane load ratings are based on the crane being leveled and standing on a firm, uniform supporting surface.
2. Crane load ratings on outriggers are based on all outrigger beams being fully extended or in the case of partial extension ratings mechanically pinned in the appropriate position, and the tires free of the supporting surface.
3. Crane load ratings on tires depend on appropriate inflation pressure and the tire conditions. Caution must be exercised when increasing air pressures in tires. Consult Operator's Manual for precautions.
4. Use of jibs, lattice-type boom extensions, or fourth section pullouts extended is not permitted for pick and carry operations.
5. Consult appropriate section of the Operator's and Service Manual for more exact description of hoist line reeving.
6. The use of more parts of line than required by the load may result in having insufficient rope to allow the hook block to reach the ground.
7. Properly maintained wire rope is essential for safe crane operation. Consult Operator's Manual for proper maintenance and inspection requirements.
8. When spin-resistant wire rope is used, the allowable rope loading shall be the breaking strength divided by five (5), unless otherwise specified by the wire rope manufacturer.
9. Do not elevate the boom above 60° unless the boom is positioned in-line with the crane's chassis or the outrigger are extended. Failure to observe this warning may result in loss of stability.

OPERATION

1. **CRANE LOAD RATINGS MUST NOT BE EXCEEDED. DO NOT ATTEMPT TO TIP THE CRANE TO DETERMINE ALLOWABLE LOADS.**
2. When either radius or boom length, or both, are between listed values, the smaller of the two listed load ratings shall be used.
3. Do not operate at longer radii than those listed on the applicable load rating chart (cross hatched areas shown on range diagrams.)
4. The boom angles shown on the Capacity Chart give an approximation of the operating radius for a specified boom length. The boom angle, before loading, should be greater to account for boom deflection. It may be necessary to retract the boom if maximum boom angle is insufficient to maintain rated radius.
5. Power telescoping boom sections must be extended equally.
6. Rated loads include the weight of hook block, slings, and auxiliary lifting devices. Their weights shall be subtracted from the listed rated load to obtain the net load that can be lifted. When lifting over the jib the weight of any hook block, slings, and auxiliary lifting devices at the boom head must be added to the load. When jibs are erected but unused add two (2) times the weight of any hook block, slings, and auxiliary lifting devices at the jib head to the load.
7. Rated loads do not exceed 85% on outriggers or 75% on tires, of the tipping load as determined by SAE Crane Stability Test Code J765a. Structural strength ratings in chart are indicated with an asterisk (*).
8. Rated loads are based on freely suspended loads. No attempt shall be made to drag a load horizontally on the ground in any direction.
9. The user shall operate at reduced ratings to allow for adverse job conditions, such as: soft or uneven ground, out of level conditions, high winds, side loads, pendulum action, jerking or sudden stopping of loads, hazardous conditions, experience of personnel, two machine lifts, traveling with loads, electric wires, etc. (side pull on boom or jib is hazardous). Derating of the cranes lifting capacity is required when wind speed exceeds 20 MPH. The center of the lifted load must never be allowed to move more than 3' off the center line of the base boom section due to the effects of wind, inertia, or any combination of the two.
Use 2' off the center line of the base boom for a two section boom, 3' for a three section boom, or 4' for a four section boom.
10. The maximum load which can be telescoped is not definable, because of variations in loadings and crane maintenance, but it is permissible to attempt retraction and extension if load ratings are not exceeded.
11. Load ratings are dependent upon the crane being maintained according to manufacturer's specifications.
12. It is recommended that load handling devices, including hooks, and hook blocks, be kept away from boom head at all times.
13. **FOR TRUCK CRANES ONLY:** 360° capacities apply only to machines equipped with a front outrigger jack and all five(5) outrigger jacks properly set. If the front (5th) outrigger jack is not properly set, the work area is restricted to the over side and over rear areas as shown on the Crane Working Positions diagram. Use the 360° load ratings in the overside work areas.
14. Do not lift with outrigger beams positioned between the fully extended and intermediate (pinned) positions.
15. Truck Cranes not equipped with equalizing (bogie) beams between the rear axles may not be used for lifting "on tires". Truck Cranes equipped with equalizing beams and rear air suspension should "dump" the air before lifting "on tires".

CLAMSHELL, MAGNET, AND CONCRETE BUCKET SERVICE

1. Maximum boom length for clamshell and magnet service is 50'.
2. Weight of clamshell or magnet, plus contents are not to exceed 6,000 lb or 90% of rated lifting capacities, whichever is less. For concrete bucket operation, weight of bucket and load must not exceed 90% of rated lifting capacity.

TEREX Cranes
106-12th Street S.E.
Waverly, Iowa 50677-9466 USA

TEL (319) 352-3920 FAX (319) 352-5727
EMAIL inquire@terexwaverly.com
WEB terex.com

WE RESERVE THE RIGHT TO AMEND THESE SPECIFICATIONS AT ANY TIME WITHOUT NOTICE. THE ONLY WARRANTY APPLICABLE IS OUR STANDARD WRITTEN WARRANTY APPLICABLE TO THE PARTICULAR PRODUCT AND SALE. WE MAKE NO OTHER WARRANTY, EXPRESSED OR IMPLIED.



TEREX RT 230

rough terrain crane
30 ton capacity

range diagram & lifting capacities

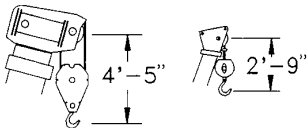

DIMENSIONS ARE FOR
LARGEST FACTORY
FURNISHED HOOK BLOCK
AND HOOK & BALL,
WITH ANTI-TWO BLOCK
ACTIVATED

Range Diagram (30' - 94' boom)

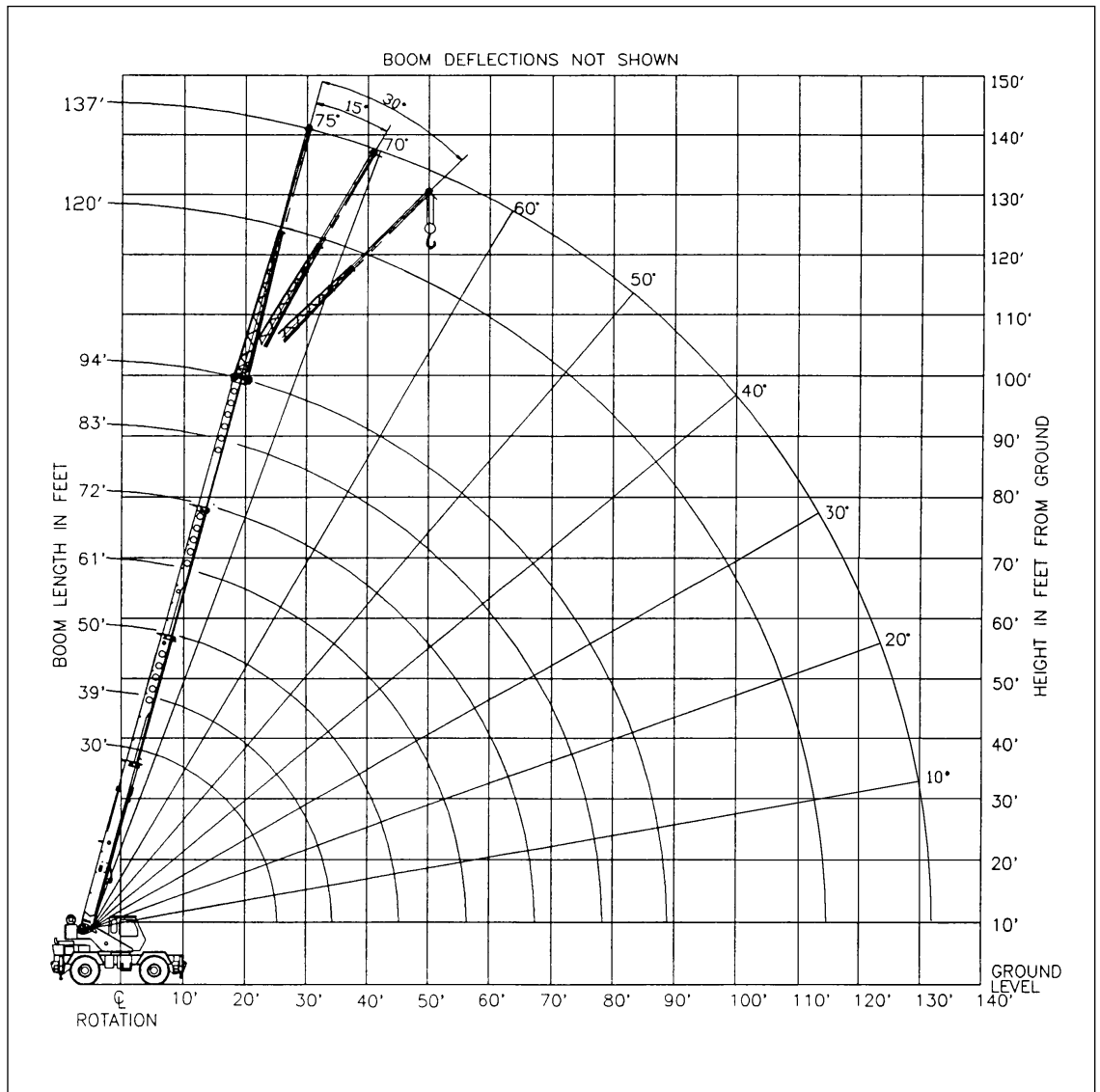

CRANE WORKING CONDITIONS

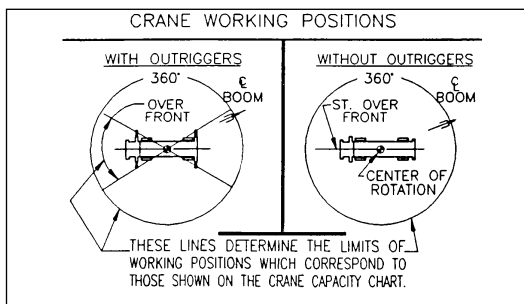

REDUCTION IN MAIN BOOM CAPACITY

All Jibs in Stowed Position _____ 0 Lbs.
Aux. Boom in Head Sheave _____ 100 Lbs.

HOOK BLOCK WEIGHTS

Hook & Ball _____ 239 Lbs.
Hook Block (2 Sheave) _____ 680 Lbs.
Hook Block (3 Sheave) _____ 660 Lbs.
Hook Block (4 Sheave) _____ 660 Lbs.

Lifting Capacities – Pounds (30’ – 94’ boom)

MODEL RT 230

COUNTERWEIGHT:
W/AUX. WINCH 8900 LBS.
W/O AUX. WINCH 10,000 LBS.
BOOM LENGTH 30-94 FT.
OUTRIGGER SPREAD 19 FT.

STABILITY PERCENTAGE
ON OUTRIGGERS 85%
ON TIRES 75%
PCSA CLASS 10-118

CAUTION: Do not use this specification sheet as a load rating chart. The format of data is not consistent with the machine chart and may be subject to change.

ON OUTRIGGERS - FULLY EXTENDED

LOAD RADIUS (FT)	BOOM LENGTH 30 FT			BOOM LENGTH 39 FT			BOOM LENGTH 50 FT			LOAD RADIUS (FT)
	LOADED BOOM ANGLE (DEG)	OVER FRONT (LB)	360° (LB)	LOADED BOOM ANGLE (DEG)	OVER FRONT (LB)	360° (LB)	LOADED BOOM ANGLE (DEG)	OVER FRONT (LB)	360° (LB)	
10	63.0	60,000*	60,000*	69.4	46,600*	46,600*				10
12	58.5	50,100*	50,100*	66.2	46,600*	46,600*	71.7	44,500*	44,500*	12
15	51.4	40,100*	40,100*	61.2	40,000*	40,000*	68.0	38,500*	38,500*	15
20	37.4	30,100*	30,100*	52.3	30,000*	30,000*	61.6	30,000*	30,000*	20
25	13.7	22,800*	22,900*	42.0	23,600*	23,600*	54.8	24,000*	24,000*	25
30	**			28.8	18,600*	18,600*	47.3	19,100*	19,100*	30
35				**			38.7	15,500*	15,100*	35
40							27.9	12,100*	11,800*	40
45							7.9	9,600*	9,300*	45
50							**			50
55										55
60										60
65										65
70										70
75										75
80										80
85										85

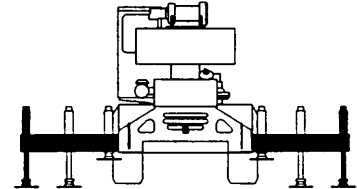

**USE THESE CHARTS ONLY
WHEN ALL OUTRIGGERS
ARE FULLY EXTENDED**

ON OUTRIGGERS - FULLY EXTENDED

LOAD RADIUS (FT)	BOOM LENGTH 61 FT			BOOM LENGTH 72 FT			BOOM LENGTH 83 FT			BOOM LENGTH 94 FT			LOAD RADIUS (FT)
	LOADED BOOM ANGLE (DEG)	OVER FRONT (LB)	360° (LB)	LOADED BOOM ANGLE (DEG)	OVER FRONT (LB)	360° (LB)	LOADED BOOM ANGLE (DEG)	OVER FRONT (LB)	360° (LB)	LOADED BOOM ANGLE (DEG)	OVER FRONT (LB)	360° (LB)	
10													10
12													12
15	72.1	36,000*	36,000*										15
20	67.1	29,500*	29,500*	70.8	27,400*	27,400*							20
25	61.9	24,000*	24,000*	66.5	23,100*	23,100*	69.8	19,000*	19,000*	72.2	15,300*	15,300*	25
30	56.3	19,400*	19,400*	62.0	19,600*	19,600*	66.0	15,900*	15,900*	69.0	13,100*	13,100*	30
35	50.4	15,700*	15,400*	57.4	15,900*	15,500*	62.2	13,800*	13,800*	65.7	11,400*	11,400*	35
40	43.9	12,400*	12,100*	52.5	12,600*	12,300*	58.1	12,000*	12,000*	62.2	10,000*	10,000*	40
45	36.5	10,000*	9,800*	47.2	10,200*	9,900*	53.9	10,300*	10,000*	58.7	8,800*	8,800*	45
50	27.3	8,200*	7,900*	41.4	8,400*	8,100*	49.5	8,500*	8,300*	55.1	7,900*	7,900*	50
55	13.0	6,700*	6,500*	34.8	7,000*	6,800*	44.7	7,100*	6,900*	51.2	7,100*	7,000*	55
60	**			26.9	5,800*	5,600*	39.5	6,000*	5,800*	47.2	6,100*	5,800*	60
65				15.5	4,800*	4,600*	33.6	5,000*	4,800*	42.8	5,100*	4,900*	65
70				**			26.6	4,200*	4,100*	38.0	4,300*	4,200*	70
75							17.0	3,500*	3,400*	32.7	3,700*	3,500*	75
80							**			26.4	3,100*	2,900*	80
85										18.1	2,600*	2,400*	85

** MAXIMUM CAPACITY AT 0 DEGREE BOOM ANGLE

BOOM LENGTH 30 FT			BOOM LENGTH 39 FT			BOOM LENGTH 50 FT			BOOM LENGTH 61 FT			BOOM LENGTH 72 FT			BOOM LENGTH 83 FT			BOOM LENGTH 94 FT		
LOAD RADIUS (FT)	OVER FRONT (LB)	360° (LB)	LOAD RADIUS (FT)	OVER FRONT (LB)	360° (LB)	LOAD RADIUS (FT)	OVER FRONT (LB)	360° (LB)	LOAD RADIUS (FT)	OVER FRONT (LB)	360° (LB)	LOAD RADIUS (FT)	OVER FRONT (LB)	360° (LB)	LOAD RADIUS (FT)	OVER FRONT (LB)	360° (LB)	LOAD RADIUS (FT)	OVER FRONT (LB)	360° (LB)
25.6	21,900*	21,900*	34.3	15,200*	14,900	45.3	9,400	9,100	56.3	6,300	6,100	67.3	4,400	4,200	78.3	3,100	2,900	89.3	2,100	2,000

Lifting Capacities – Pounds (30’ – 94’ boom)

MODEL RT 230

COUNTERWEIGHT:
W/AUX. WINCH 8900 LBS.
W/O AUX. WINCH 10,000 LBS.
BOOM LENGTH 30-94 FT.
OUTRIGGER SPREAD 19 FT.

STABILITY PERCENTAGE
ON OUTRIGGERS 85%
ON TIRES 75%
PCSA CLASS 10-118



CAUTION: Do not use this specification sheet as a load rating chart. The format of data is not consistent with the machine chart and may be subject to change.

ON OUTRIGGERS - MID POSITION

LOAD RADIUS (FT)	BOOM LENGTH 30 FT		BOOM LENGTH 39 FT		BOOM LENGTH 50 FT		BOOM LENGTH 61 FT		BOOM LENGTH 72 FT		BOOM LENGTH 83 FT		BOOM LENGTH 94 FT		LOAD RADIUS (FT)
	LOADED BOOM ANGLE (DEG)	360° (LB)	LOADED BOOM ANGLE (DEG)	360° (LB)	LOADED BOOM ANGLE (DEG)	360° (LB)	LOADED BOOM ANGLE (DEG)	360° (LB)	LOADED BOOM ANGLE (DEG)	360° (LB)	LOADED BOOM ANGLE (DEG)	360° (LB)	LOADED BOOM ANGLE (DEG)	360° (LB)	
10	63.0	60,000*	69.4	46,600*											10
12	58.5	50,100*	66.2	46,600*	71.7	44,500*									12
15	51.4	38,000	61.2	38,700	68.0	38,500*	72.1	36,000*							15
20	37.4	21,500	52.3	22,300	61.6	22,700	67.1	23,000	70.8	23,100					20
25	13.7	13,800	42.0	14,700	54.8	15,200	61.9	15,400	66.5	15,600	69.8	15,700	72.2	15,300*	25
30	**		28.8	10,300	47.3	10,900	56.3	11,100	62.0	11,200	66.0	11,400	69.0	11,400	30
35			**		38.7	8,000	50.4	8,300	57.4	8,400	62.2	8,500	65.7	8,600	35
40					27.9	5,900	43.9	6,300	52.5	6,500	58.1	6,600	62.2	6,600	40
45					7.9	4,400	36.5	4,800	47.2	5,000	53.9	5,100	58.7	5,200	45
50					**		27.3	3,600	41.4	3,800	49.5	4,000	55.1	4,100	50
55							13.0	2,600	34.8	2,900	44.7	3,100	51.2	3,200	55
60							**		26.9	2,100	39.5	2,300	47.2	2,400	60
65									15.5	1,500	33.6	1,700	42.8	1,800	65
70											26.6	1,100	38.0	1,300	70

** MAXIMUM CAPACITY AT 0 DEGREE BOOM ANGLE

BOOM LENGTH 30 FT		BOOM LENGTH 39 FT		BOOM LENGTH 50 FT		BOOM LENGTH 61 FT		BOOM LENGTH 72 FT		BOOM LENGTH 83 FT		BOOM LENGTH 94 FT	
LOAD RADIUS (FT)	360° (LB)	LOAD RADIUS (FT)	360° (LB)	LOAD RADIUS (FT)	360° (LB)	LOAD RADIUS (FT)	360° (LB)	LOAD RADIUS (FT)	360° (LB)	LOAD RADIUS (FT)	360° (LB)	LOAD RADIUS (FT)	360° (LB)
25.6	12,900	34.3	7,600	45.3	4,200	56.3	2,400	67.3	1,200				

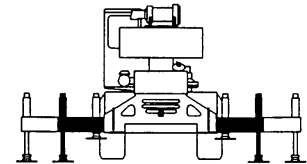

USE THESE CHARTS ONLY WHEN ALL OUTRIGGERS ARE PINNED IN MID POSITION

ON OUTRIGGERS - RETRACTED

LOAD RADIUS (FT)	BOOM LENGTH 30 FT		BOOM LENGTH 39 FT		BOOM LENGTH 50 FT		BOOM LENGTH 61 FT		BOOM LENGTH 72 FT		BOOM LENGTH 83 FT		BOOM LENGTH 94 FT		LOAD RADIUS (FT)
	LOADED BOOM ANGLE (DEG)	360° (LB)	LOADED BOOM ANGLE (DEG)	360° (LB)	LOADED BOOM ANGLE (DEG)	360° (LB)	LOADED BOOM ANGLE (DEG)	360° (LB)	LOADED BOOM ANGLE (DEG)	360° (LB)	LOADED BOOM ANGLE (DEG)	360° (LB)	LOADED BOOM ANGLE (DEG)	360° (LB)	
10	63.0	32,800	69.4	33,400											10
12	58.5	23,600	66.2	24,200	71.7	24,600									12
15	51.4	15,800	61.2	16,500	68.0	16,900	72.1	17,100							15
20	37.4	9,100	52.3	9,800	61.6	10,300	67.1	10,500	70.8	10,600					20
25	13.7	5,300	42.0	6,200	54.8	6,700	61.9	6,900	66.5	7,100	69.8	7,200	72.2	7,200	25
30	**		28.8	3,900	47.3	4,400	56.3	4,700	62.0	4,900	66.0	5,000	69.0	5,100	30
35			**		38.7	2,900	50.4	3,200	57.4	3,400	62.2	3,500	65.7	3,600	35
40					27.9	1,700	43.9	2,100	52.5	2,300	58.1	2,400	62.2	2,500	40
45							36.5	1,200	47.2	1,400	53.9	1,500	58.7	1,600	45
50											49.5	900	55.1	1,000	50

** MAXIMUM CAPACITY AT 0 DEGREE BOOM ANGLE

BOOM LENGTH 30 FT		BOOM LENGTH 39 FT		BOOM LENGTH 50 FT		BOOM LENGTH 61 FT		BOOM LENGTH 72 FT		BOOM LENGTH 83 FT		BOOM LENGTH 94 FT	
LOAD RADIUS (FT)	360° (LB)	LOAD RADIUS (FT)	360° (LB)	LOAD RADIUS (FT)	360° (LB)	LOAD RADIUS (FT)	360° (LB)	LOAD RADIUS (FT)	360° (LB)	LOAD RADIUS (FT)	360° (LB)	LOAD RADIUS (FT)	360° (LB)
25.6	4,900	34.3	2,400										

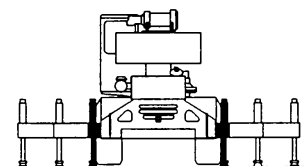

USE THESE CHARTS WHEN ALL OUTRIGGER BEAMS ARE NOT IN EITHER THE MID OR FULLY EXTENDED POSITION

Lifting Capacities – Pounds (30' – 94' boom)

MODEL RT 230

COUNTERWEIGHT:
W/AUX. WINCH 8900 LBS.
W/O AUX. WINCH 10,000 LBS.
BOOM LENGTH 30-94 FT.
OUTRIGGER SPREAD 19 FT.

STABILITY PERCENTAGE
ON OUTRIGGERS 85%
ON TIRES 75%
PCSA CLASS 10-118

CAUTION: Do not use this specification sheet as a load rating chart. The format of data is not consistent with the machine chart and may be subject to change.

SIDE STOW JIB ON FULLY EXTENDED OUTRIGGERS

LOADED BOOM ANGLE (DEG)	26 FT OFFSETTABLE JIB						43 FT OFFSETTABLE JIB						LOADED BOOM ANGLE (DEG)
	0° OFFSET		15° OFFSET		30° OFFSET		0° OFFSET		15° OFFSET		30° OFFSET		
	LOAD RADIUS (REF) (FT)	360° (LB)	LOAD RADIUS (REF) (FT)	360° (LB)	LOAD RADIUS (REF) (FT)	360° (LB)	LOAD RADIUS (REF) (FT)	360° (LB)	LOAD RADIUS (REF) (FT)	360° (LB)	LOAD RADIUS (REF) (FT)	360° (LB)	
75	35	9,100*	40	7,400*	45	5,600*	41	5,100*	50	3,400*	62	2,700*	75
73	39	8,600*	43	6,800*	49	5,300*	45	4,800*	54	3,300*	65	2,700*	73
71	43	8,100*	47	6,300*	52	5,000*	49	4,500*	58	3,200*	68	2,600*	71
68	49	7,300*	52	5,600*	56	4,500*	54	4,100*	64	3,000*	72	2,500*	68
65	54	6,300*	57	5,100*	61	4,100*	60	3,800*	70	2,900*	77	2,500*	65
62	60	5,500*	62	4,600*	66	3,700*	67	3,600*	74	2,800*	82	2,400*	62
59	64	4,800*	67	4,100*	71	3,400*	75	3,400*	81	2,700*	88	2,400*	59
55	70	4,100*	73	3,600*	78	3,000*	82	3,100*	89	2,600*	95	2,300*	55
51	76	3,500	79	3,200*	84	2,800*	88	2,900*	96	2,500*	100	2,300*	51
47	82	2,800	86	2,600	89	2,500*	95	2,500	101	2,100	105	2,000	47
43	87	2,300	91	2,200	93	2,300	101	2,100	107	1,700	110	1,600	43
38	93	1,800	97	1,800	98	1,800	108	1,700	113	1,300	115	1,300	38
32	100	1,400	102	1,400	104	1,400	116	1,200	119	1,000	121	1,000	32
25	106	1,000	108	1,000									25

NOTES FOR JIB CAPACITIES

- A. For all boom lengths less than the maximum with a jib erected, the rated loads are determined by boom angle only in the appropriate column.
- B. For boom angle not shown, use the capacity of the next lower boom angle.
- C. Listed radii are for extended main boom only.

ON TIRES

RADIUS (FT)	MAX BOOM LENGTH (FT)	16:00 X 25-28PR				20:50 X 25-24PR				RADIUS (FT)
		STATIONARY		PICK & CARRY		STATIONARY		PICK & CARRY		
		360°	STRAIGHT OVER FRONT	CREEP	2.5 MPH	360°	STRAIGHT OVER FRONT	CREEP	2.5 MPH	
10	30	23,600	45,900*	36,100*	26,500*	24,000	44,200*	34,700*	23,700*	10
12	30	17,300	39,700*	31,100*	22,600*	19,000	35,300*	29,900*	20,200*	12
15	39	13,000	27,400	25,400*	18,200*	14,100	27,400	24,400*	16,100*	15
20	39	8,000	16,200	16,200	13,200*	8,400	16,600	16,600	11,500*	20
25	50	5,200	11,000	11,000	9,700*	5,400	11,200	11,200	8,300*	25
30	50	3,200	7,900	7,900	7,500*	3,400	8,100	8,100	6,300*	30
35	50	1,900	6,100	6,100	6,000*	2,000	6,100	6,100	5,000*	35
40	61	1,200	4,900	4,900	4,800*	1,300	4,900	4,900	3,900*	40
45	61		3,800	3,800	3,800		3,900	3,900	3,100*	45
50	61		2,700	2,700	2,700		2,800	2,800	2,400*	50
55	61		2,000	2,000	2,000		2,100	2,100	1,800*	55
60	72		1,500	1,500	1,500		1,500	1,500	1,300*	60
65	72		1,100	1,100	1,100		1,200	1,200	900*	65

NOTES FOR ON TIRE CAPACITIES

- A. For Pick and Carry operations, boom must be centered over the front of the crane with swing brake and lock engaged. Use minimum boom point height and keep load close to ground surface.
- B. The load should be restrained from swinging. NO ON TIRE OPERATION WITH JIB ERECTED.
- C. Without outriggers, never maneuver the boom beyond listed load radii for applicable tires to ensure stability.
- D. Creep speed is crane movement of less than 200 Ft. (61m) in a 30 minute period and not exceeding 1.0 mph(1.6 km/h).
- E. Refer to General Notes for additional information.

MAXIMUM PERMISSIBLE HOIST LINE LOAD

LINE PARTS	1	2	3	4	5	6	7
MAX. LOAD	9,080	18,160	27,240	36,320	45,400	54,480	63,560
BOOM HEAD	2	3-D	2-3	1-4-D	2-3-4	2-3-4-D	1-2-3-4
HOOK BLOCK	D	3	3-D	1-4	2-3-D	2-3-4	2-3-4-D
WIRE ROPE: 5/8" ROTATION RESISTANT COMPACTED STRAND, 18X19 OR 19X19 MINIMUM BREAKING STRENGTH - 22.7 TONS 5/8" 6X19 OR 6X37 IWRC IPS PREFORMED RIGHT REGULAR LAY MINIMUM BREAKING STRENGTH - 17.9 TONS							

RECOMMENDED TIRE PRESSURE

TIRE SIZE	STATIONARY	CREEP	2 1/2 MPH	TRAVEL
16:00 X 25-28PR	115 PSI	115 PSI	95 PSI	95 PSI
20:50 x 25-24PR	95 PSI	95 PSI	70 PSI	70 PSI

GENERAL NOTES

GENERAL

1. Rated loads as shown on Lift Charts pertain to this machine as originally manufactured and equipped. Modifications to the machine or use of optional equipment other than that specified can result in a reduction of capacity.
2. Construction equipment can be hazardous if improperly operated or maintained. Operation and maintenance of this machine shall be in compliance with the information in the Operator's, Parts and Safety Manuals supplied with this machine. If these manuals are missing, order replacements from the manufacturer through your distributor.
3. These warnings do not constitute all of the operating conditions for the crane. The operator and job site supervision must read the OPERATORS MANUAL, CIMA SAFETY MANUAL, APPLICABLE OSHA REGULATIONS, AND SOCIETY OF MECHANICAL ENGINEERS (ASME) SAFETY STANDARDS FOR CRANES.
4. This crane and its load ratings are in accordance with POWER CRANE & SHOVEL ASSOCIATION, STANDARD NO. 4, SAE CRANE LOAD STABILITY TEST CODE J765A, SAE METHOD OF TEST FOR CRANE STRUCTURE J1063 AND APPLICABLE SAFETY CODE FOR CRANES, DERRICKS AND HOISTS, ASME/ANSI B30.5.

DEFINITIONS

1. **LOAD RADIUS** – The horizontal distance from the axis of rotation before loading to the center of the vertical hoist line or tackle with a load applied.
2. **LOADED BOOM ANGLE** – It is the angle between the boom base section and the horizontal, after lifting the rated load at the rated radius. The boom angle before loading should be greater to account for deflections. The loaded boom angle combined with boom length give only an approximation of the operating radius.
3. **WORKING AREA** – Areas measured in a circular arc about the centerline of rotation as shown in the diagram.
4. **FREELY SUSPENDED LOAD** – Load hanging free with no direct external force applied except by the hoist rope.
5. **SIDE LOAD** – Horizontal force applied to the lifted load either on the ground or in the air.
6. **NO LOAD STABILITY LIMIT** – The stability limit radius shown on the range diagrams is the radius beyond which it is not permitted to position the boom, when the boom angle is less than the minimum shown on the applicable load chart, because the machine can overturn without any load.
7. **BOOM SIDE OF CRANE** – The side of the crane over which the boom is positioned when in an OVER SIDE working position.

SET-UP

1. Crane load ratings are based on the crane being leveled and standing on a firm, uniform supporting surface.
2. Crane load ratings on outriggers are based on all outrigger beams being fully extended or in the case of partial extension ratings mechanically pinned in the appropriate position, and the tires free of the supporting surface.
3. Crane load ratings on tires depend on appropriate inflation pressure and the tire conditions. Caution must be exercised when increasing air pressures in tires. Consult Operator's Manual for precautions.
4. Use of jibs, lattice-type boom extensions, or fourth section pullouts extended is not permitted for pick and carry operations.
5. Consult appropriate section of the Operator's and Service Manual for more exact description of hoist line reeving.
6. The use of more parts of line than required by the load may result in having insufficient rope to allow the hook block to reach the ground.
7. Properly maintained wire rope is essential for safe crane operation. Consult Operator's Manual for proper maintenance and inspection requirements.
8. When spin-resistant wire rope is used, the allowable rope loading shall be the breaking strength divided by five (5), unless otherwise specified by the wire rope manufacturer.
9. Do not elevate the boom above 60° unless the boom is positioned in-line with the crane's chassis or the outriggers are extended. Failure to observe this warning may result in loss of stability.

OPERATION

1. **CRANE LOAD RATINGS MUST NOT BE EXCEEDED. DO NOT ATTEMPT TO TIP THE CRANE TO DETERMINE ALLOWABLE LOADS.**
 2. When either radius or boom length, or both, are between listed values, the smaller of the two listed load ratings shall be used.
 3. Do not operate at longer radii than those listed on the applicable load rating chart (cross hatched areas shown on range diagrams).
 4. The boom angles shown on the Capacity Chart give an approximation of the operating radius for a specified boom length. The boom angle, before loading, should be greater to account for boom deflection. It may be necessary to retract the boom if maximum boom angle is insufficient to maintain rated radius.
 5. Power telescoping boom sections must be extended equally.
 6. Rated loads include the weight of hook block, slings, and auxiliary lifting devices. Their weights shall be subtracted from the listed rated load to obtain the net load that can be lifted.
When lifting over the jib the weight of any hook block, slings, and auxiliary lifting devices at the boom head must be added to the load.
When jibs are erected but unused add two (2) times the weight of any hook block, slings, and auxiliary lifting devices at the jib head to the load.
 7. Rated loads do not exceed 85% on outriggers or 75% on tires, of the tipping load as determined by SAE Crane Stability Test Code J765a. Structural strength ratings in chart are indicated with an asterisk (*).
 8. Rated loads are based on freely suspended loads. No attempt shall be made to drag a load horizontally on the ground in any direction.
 9. The user shall operate at reduced ratings to allow for adverse job conditions, such as: Soft or uneven ground, out of level conditions, high winds, side loads, pendulum action, jerking or sudden stopping of loads, hazardous conditions, experience of personnel, two machine lifts, traveling with loads, electric wires, etc., (side pull on boom or jib is hazardous). Derating of the cranes lifting capacity is required when wind speed exceeds 20 MPH. the center of the lifted load must never be allowed to move more than 3* feet off the center line of the base boom section due to the effects of wind, inertia, or any combination of the two.
**Use 2 feet off the center line of the base boom for a two section boom, 3 feet for a three section boom, or 4 feet for a four section boom.
 10. The maximum load which can be telescoped is not definable, because of variations in loadings and crane maintenance, but it is permissible to attempt retraction and extension if load ratings are not exceeded.
 11. Load ratings are dependent upon the crane being maintained according to manufacturer's specifications.
 12. It is recommended that load handling devices, including hooks, and hook blocks, be kept away from boom head at all times.
 13. **FOR TRUCK CRANES ONLY:** 360° capacities apply only to machines equipped with a front outrigger jack and all five (5) outrigger jacks properly set. If the front (5th) outrigger jack is not properly set, the work area is restricted to the over side and over rear areas as shown on the Crane Working Positions diagram. Use the 360° load ratings in the overside work areas.
 14. Do not lift with outrigger beams positioned between the fully extended and intermediate (pinned) positions.
 15. Truck Cranes not equipped with equalizing (bogie) beams between the rear axles may not be used for lifting "on tires". Truck Cranes equipped with equalizing beams and rear air suspension should "dump" the air before lifting "on tires".
- ### CLAMSHELL, MAGNET, AND CONCRETE BUCKET SERVICE
1. Maximum boom length for clamshell and magnet service is 50 feet.
 2. Weight of clamshell or magnet, plus contents are not to exceed 6,000 pounds or 90% of rated lifting capacities, whichever is less. For concrete bucket operation, weight of bucket and load must not exceed 90% of rated lifting capacity.

WE RESERVE THE RIGHT TO AMEND THESE SPECIFICATIONS AT ANY TIME WITHOUT NOTICE. THE ONLY WARRANTY APPLICABLE IS OUR STANDARD WRITTEN WARRANTY APPLICABLE TO THE PARTICULAR PRODUCT AND SALE. WE MAKE NO OTHER WARRANTY, EXPRESSED OR IMPLIED.



106 12th Street S.E.
Waverly, IA 50677-9466 USA
(319) 352-3920 • FAX: (319) 352-5727
E-mail: inquire@terexwaverly.com

www.terexlift.com