



SANY
AMERICA INC.

SRC865XL
Product Guide



FEATURES

- 65 US T Capacity @ 10 ft. Radius
- 18,210 lbs Hoist Max Line Pull
- 37.3'-139.4' Main Boom
- 30.2'-52.5' Boom Extension
- Cummins QSB6.7 250 HP Engine

OPERATOR'S CAB



Spacious ergonomic cab with all steel construction. Optimum visibility, tinted safety glass through. Opening skylight with visor and wiper system. Sliding door on the left hand side and a framed sliding window on the right hand side. Acoustical foam to absorb noise and insulate the cab. Deluxe six-way adjustable seat is equipped with mechanical suspension and includes arm rests and head rest.

SANY DESIGNED LOAD MOMENT LIMITER (LML)

The user friendly SANY designed LML is prominently displayed and simple to set up and operate.



HIGH QUALITY, NAME BRAND COMPONENTS



Cummins engine coupled to **Parker & Husco** hydraulic components and **Braden Winches** deliver high reliability and consistent performance.

SRC865XL



- Engine: **Cummins** Model QSB6.7 250 HP @ 2500 rpm
- Hydraulic system: **Parker** Piston Pumps and **Husco** Valves
- **Braidon** Winches
- SANY designed LML with large display screen
- **AxleTech** Axles and **Dana** Powershift Transmission
- 139.4 Foot Five Section Main Boom and 30.2' – 52.5' Extension
- Key standard features
 - Large Cab
 - Horsepower Limited Pumps
 - Hydraulic Joystick Controls
 - Post Compensated Valves
 - SANY 24 Volt Electrical Control System

Maximum Capacity @ Radius	65 US Ton @ 10 ft
Main Boom	37.3 ft – 139.4 ft
Max Tip Height with Extension	198.2 ft
Boom Extension	30.2 ft – 52.5 ft
Hoist Max Line Pull	18,210 lbs
Wire Rope Diameter	3/4 in.
Weight	98,340 lbs
Length	45 ft 11 in.
Height	12 ft 4.5 in.
Max Gradeability	111% GVW
Width	10 ft 10 in.
Tail Swing	13 ft 10 in.

ENGINE

Cummins Model QSB6.7 Tier 3
 Power..... 250 HP (186.4 Kw)
 Fuel Tank 90 Gal. (340L)



HYDRAULIC SYSTEM

Parker horsepower limited piston pumps with Husco post compensated valves provides multifunction load sharing and fine control. Energy saving system offers a lower operational cost. Oil cooler and pressure filter to ensure long component life.



CONTROLS

Pilot operated, hydraulic joysticks produce smooth variable control of crane functions. Drum rotation indicators are incorporated in the handles. Steering column mounted turn signals and transmission control. Foot pedals for swing brake, telescope, service brake and accelerator. Hi-Low hoist speed control switch in handle for ease of use. SANY electrical system includes LML and lockout with CAN bus for reduced complexity. Built in diagnostics and engine instrumentation display. Electrical system is 24 volt.



SWING SYSTEM

The swing system can rotate 360 degrees continuously in both directions. Independent swing circuit eliminates function interaction. Planetary drive offers free swing or automatic brake application for operator preference. Maximum speed 2.5 RPM with a 13 ft 10 in. tailswing.



HOISTS

Braden main and auxiliary hoists are independently driven and controlled by the joysticks.

Rope Diameter 3/4"
 Max Line Speed 492 ft/min
 Max Line Pull 18,210 lbs
 Drum Capacity 906 ft



COUNTERWEIGHT

Bolt on 12,000 pound counterweight.



OPERATOR'S CAB

Spacious ergonomic cab with all steel construction. Optimum visibility, tinted safety glass throughout. Opening skylight with visor and wiper system. Diesel heater and defroster. Sliding door on the left hand side and a framed sliding window on the right hand side. Acoustical foam to absorb noise and insulate the cab. Deluxe six-way adjustable seat is equipped with mechanical suspension and includes arm rests and head rest.



BOOM

Five section sequenced synchronized full power boom.

(37.3' – 139.4') Boom elevation -2° to 78° with a maximum tip height of 146.6 ft. Side mounted bifold boom extension (30.2' – 52.5') with 0°, 15°, and 30° offset. Maximum tip height of 198.2 ft.



CARRIER

Equipped with hydraulic powered four way steering for excellent maneuverability. Three position outriggers provide 14" of ground penetration and 23.6 ft of extension to level the crane. Superior accessibility from ground for ease of maintenance. Earthmover style 29.5 X 25 (28 PR) tires provide excellent flotation for off road use. Dana powershift transmission includes 6 speeds forward and reverse with a maximum speed of 25 MPH. AxleTech drive steer axles are supplied with hydraulic disk brakes and a spring applied parking brake.

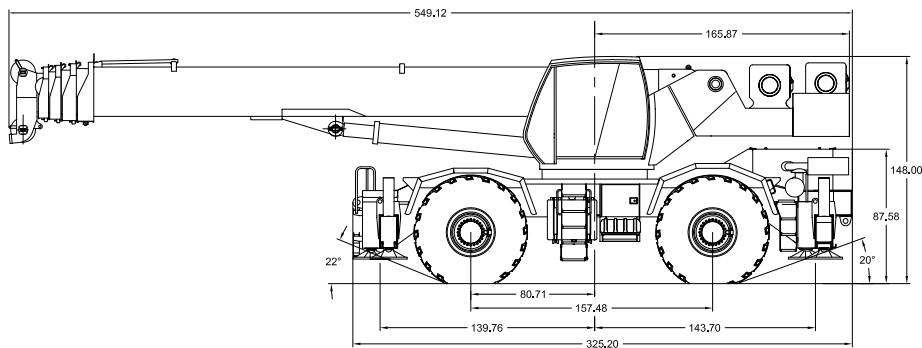
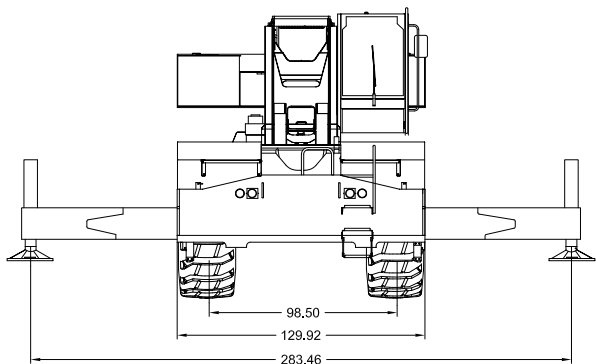

Anti-Two-Block (A2B)

A limit switch and an actuation weight on load lines are provided to prevent two-blocking of the hook block and the overhaul ball. When the lifting hook reaches its maximum height, a limit switch will activate the buzzer on the control panel, meanwhile the indicator light will blink and automatically stop the lifting operation of hook block.

Backup Alarm

A backup alarm will operate when the machine is placed in reverse.

Crane Level Indicator

A bubble level displaying the machine angle is mounted in the operators cab.

Boom Angle Indicator

An angle indicator is mounted on the side of the base section to show the boom angle. The boom angle is also displayed on the LML console.

Boom Length Indicator

A cable reel is provided to measure the boom length and it is displayed on the LML console.

Load Holding Valves

Load holding valves are provided on all cylinders that support the load to prevent uncontrolled lowering of the boom in the event of a hydraulic system failure (e.g., supply hose rupture).

Load Moment Limiter (LML)

A Load Moment Limiter (LML) system is supplied to monitor the hook load and compare it with the rated load for the configuration selected by the operator.

Outrigger Jack Integral Holding Valve

All four outrigger jacks are supplied with an integral holding valve to prevent cylinder retraction in the event of a hose failure.

Outrigger Position Sensor

Each outrigger beam is supplied with a position sensor to monitor the extension of the outrigger.

Hoist Drum Rotation Indicator

All drums are equipped with an electric drum rotation indicator device that will vibrate the operator's joystick as the drum rotates.

Horn

The crane is supplied with a horn for the operator to warn personnel in the vicinity of the crane..

Drum Brake

All hoist drums are equipped with a spring applied hydraulic released brake. The brake will automatically apply when the control handle returns to neutral.

Function Cut-Out

If the arm rest is raised, all crane functions for operating the superstructure will be deactivated.

Lighting

Equipped with driving lights in front of machine, stop turn & tail lights in the rear of the machine, operator's cab interior light, and a spot light mounted on the front of the cab.

Rearview Mirror

Externally installed on the left of the operator's cab for monitoring the rear of the machine.

Swing Lock

Mechanical pin lock to lock the crane in front positions.

Seat Switch



The operator must be seated for all machine functions to work.

Third Wrap Indicator

A roller riding on the hoist wire rope will actuate a switch to warn the operator when 3 wraps are remaining. The system will sound a buzzer and an alarm indicator will be displayed on the instrument cluster and automatically stop the drum movement.

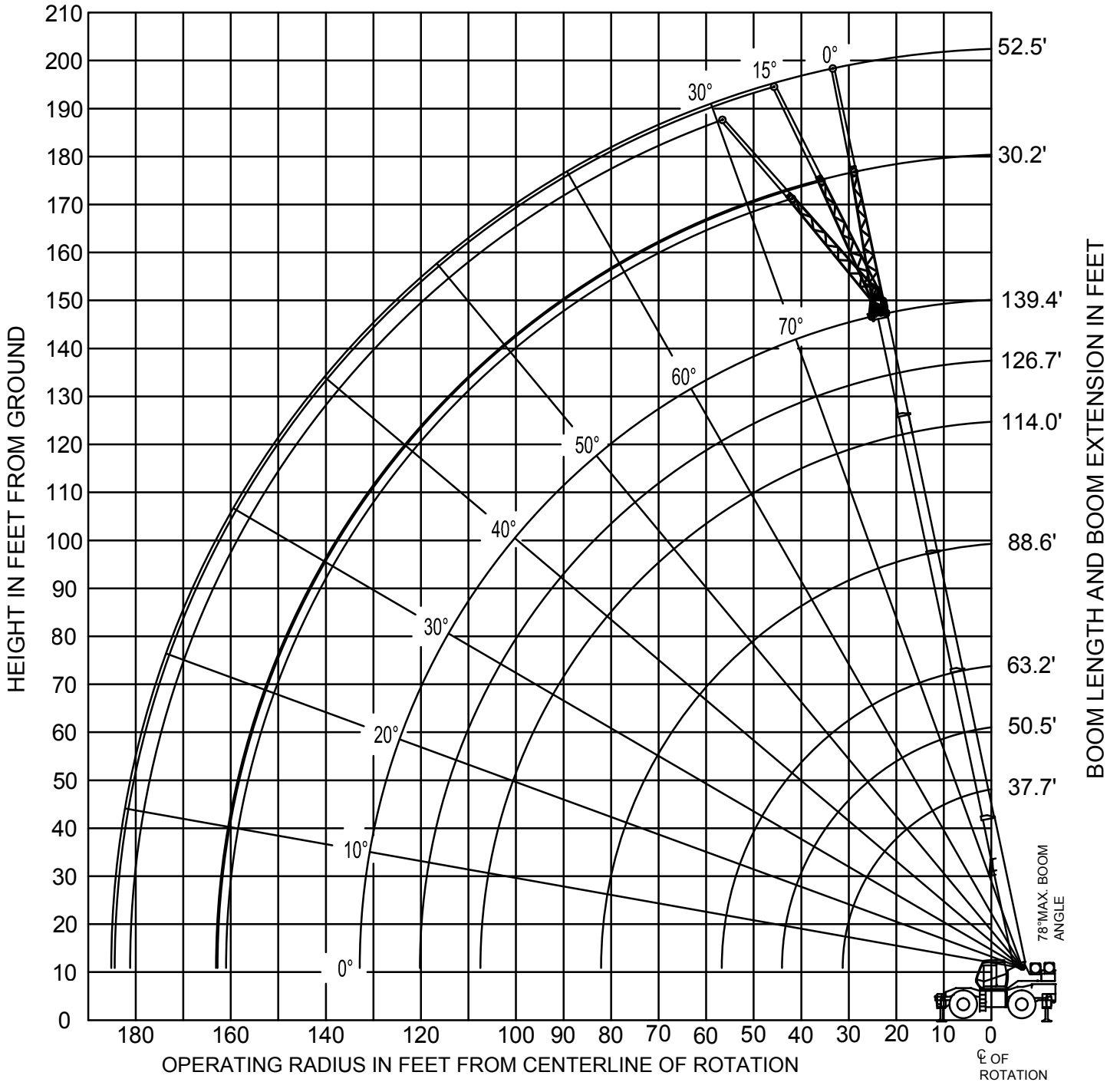
WORKING RANGE DIAGRAM
(BOOM DEFLECTION NOT SHOWN)
SANY SRC865XL





SRC865XL MAIN BOOM - ON OUTRIGGERS - 50% EXTENDED, 360°							
	 Main Boom	 Outriggers Fully Extended	 360°				
RADIUS FT	Boom Length - Feet						
	37.7	50.5	63.2	88.6	114.0	126.7	139.4
10	130000 (68.5)	89290 (76)	70550 * (78)				
12	107110 (65.5)	89290 (73)	70550 (77)				
15	89760 (60)	88390 (69.5)	67730 (74)	46300 * (78)			
20	67700 (50)	67440 (63)	56540 (69)	45640 (76)	30860 * (78)		
25	52910 (38)	51590 (56.5)	46710 (64)	36200 (72.5)	29230 (77.5)	25090 * (78)	
30	41030 (21.5)	40080 (48.5)	38730 (58.5)	31300 (69)	25490 (75)	22840 (76.5)	18590 * (78)
35		28420 (39.5)	28570 (52.5)	26430 (65.5)	22230 (72)	19470 (74)	16900 (77)
40		22210 (27.5)	20770 (46.5)	21640 (62)	18540 (69.5)	16410 (72)	14860 (74.5)
45			16260 (39)	18410 (58)	16980 (66.5)	15420 (69.5)	13780 (72.5)
50			12850 (31)	15200 (54)	14540 (64)	13850 (66.5)	12460 (70.5)
55			10400 (17.5)	12440 (49.5)	12550 (61)	12420 (64.5)	11340 (67.5)
60				10230 (45)	11190 (58)	11250 (61.5)	10470 (65.5)
65				8490 (40)	9730 (54.5)	10130 (59)	9550 (63)
70				7070 (34)	8320 (51.5)	8760 (56)	8670 (60.5)
75				5920 (26.5)	7090 (48)	7520 (53)	7740 (58)
80				4870 (17.5)	6030 (44)	6410 (50)	6780 (55.5)
85					5100 (40.5)	5310 (47)	5850 (53)
90					4320 (35.5)	4680 (43.5)	5170 (50)
95					3620 (30.5)	4040 (40)	4430 (47)
100					2940 (24.5)	3410 (36)	3730 (44)
105						2860 (31.5)	3180 (40.5)
110						2340 (26)	2680 (37)
115						1870 (19.5)	2210 (33)
120						1270 (16)	1760 (28.5)
125							1200 (23)
MIN BOOM ANGLE	0°	0°	0°	0°	0°	0°	12°
PARTS LINE	10	8	8	6	4	4	3



Boom Angle	Main Boom Length - Feet					
	37.7	50.5	63.2	88.6	114.0	126.7
0°	29760 (31.1)	18170 (43.9)	9640 (56.6)	4470 (82.0)	2040 (107.4)	1250 (120.1)

Number in parentheses () is the Boom Angle in Degrees.
 * This rated load is with the boom at the maximum boom angle.

SRC865XL LOAD CHARTS

SRC865XL MAIN BOOM - ON OUTRIGGERS - 50% EXTENDED, 360°							
		 Main Boom		 Outriggers 50% Extended		 360°	
RADIUS FT	Boom Length - Feet						
	37.7	50.5	63.2	88.6	114.0	126.7	139.4
10	121250 (68.5)	89290 (76)	70550 * (78)				
12	107110 (65.5)	89290 (73)	70550 (77)				
15	88540 (60)	87010 (69.5)	67730 (74)	46300 * (78)			
20	48130 (50)	47200 (63)	46660 (69)	45640 (76)	30860 * (78)		
25	30360 (38)	29550 (56.5)	29060 (64)	32770 (72.5)	29380 (77.5)	25090 * (78)	
30	20680 (21)	20050 (48.5)	19590 (58.5)	22930 (69)	24790 (75)	22840 (76.5)	18590 * (78)
35		14060 (39.5)	13620 (52.5)	16720 (65.5)	18450 (72)	19050 (74)	16900 (77)
40		9970 (28)	9530 (46.5)	12460 (62)	14090 (69.5)	14670 (72)	14860 (74.5)
45			6560 (39)	9380 (58)	10950 (66.5)	11500 (69.5)	11950 (72.5)
50			4330 (31)	7050 (54)	8570 (64)	9100 (66.5)	9540 (70.5)
55			2630 (18)	5170 (49.5)	6650 (61)	7160 (64.5)	7580 (67.5)
60				3630 (45)	5080 (58)	5580 (61.5)	5990 (65.5)
65				2400 (40)	3810 (54.5)	4310 (59)	4710 (63)
70				1380 (34)	2770 (51.5)	3250 (56)	3660 (60.5)
75					1870 (48)	2350 (53)	2750 (58)
80							1950 (55.5)
85							1220 (53)
MIN BOOM ANGLE	0°	0°	0°	25.5°	39.5°	43.5°	47°
PARTS LINE	10	8	8	6	4	4	3



Boom Angle	Main Boom Length - Feet		
	37.7	50.5	63.2
0°	19070 (31.1)	7580 (43.9)	2160 (56.6)

SRC865XL MAIN BOOM - ON OUTRIGGERS RETRACTED, 360°							
		 Main Boom		 Outriggers Retracted		 360°	
RADIUS FT	Boom Length - Feet						
	37.7	50.5	63.2	88.6	114.0	126.7	139.4
10	80460 (68.5)	79360 (76)	70540 * (78)				
12	60680 (65.5)	59630 (73)	59030 (77)				
15	38660 (60)	37780 (69.5)	37270 (74)	41350 * (78)			
20	21920 (50)	21170 (63)	20720 (69)	24090 (76)	25980 * (78)		
25	13670 (38)	12970 (56.5)	12550 (64)	15570 (72.5)	17260 (77.5)	17850 * (78)	
30	8710 (21.5)	8090 (48.5)	7690 (58.5)	10500 (69)	12060 (75)	12610 (76.5)	13060 (78)
35		4820 (39.5)	4430 (52.5)	7100 (65.5)	8580 (72)	9100 (74)	9530 (77)
40		2460 (28)	2110 (46.5)	4670 (62)	6100 (69.5)	6600 (72)	7010 (74.5)
45				2860 (58)	4250 (66.5)	4730 (69.5)	5130 (72.5)
50				1500 (54)	2820 (64)	3290 (66.5)	3680 (70.5)
55					1650 (61)	2110 (64.5)	2490 (67.5)
60						1130 (61.5)	1500 (65.5)
MIN BOOM ANGLE	0°	0°	38.5°	48.5°	55.5°	59°	61°
PARTS LINE	8	8	8	4	3	3	3

Boom Angle	Main Boom Length - Feet	
	37.7	50.5
0°	8030 (31.1)	1060 (43.9)

Number in parentheses () is the Boom Angle in Degrees.
 * This rated load is with the boom at the maximum boom angle.

SRC865XL - LOAD STATIONARY, ON TIRES, 360°



Stationary On Tires  360° 				
RADIUS FT	Boom Length - Feet			
	37.7	50.5	63.2	88.6
10	32440 (70)	31790 (75.5)	31390 * (78)	
12	26610 (66.5)	25980 (73.5)	25590 (77)	
15	20070 (61.5)	19460 (69.5)	19080 (74.5)	20000 * (78)
20	11530 (51.5)	10980 (63)	10650 (69.5)	13120 (76.5)
25	6860 (39.5)	6340 (56)	6030 (64.5)	8280 (73)
30	4140 (20.5)	3460 (48.5)	3160 (59)	5280 (69.5)
35		1500 (39.5)	1200 (53)	3230 (66)
40				1730 (62)
MIN BOOM ANGLE	0°	36°	48°	57.5°
PARTS LINE	6	6	6	6

Boom Angle	Main Boom Length - Feet		
	37.7	50.5	63.2
0°	3430 (31.1)		

NOTES TO ALL ON TIRE CAPACITY CHARTS:



1. Capacities are in pounds and do not exceed 75% of tipping loads as tested in accordance with SAE J765.
2. Capacities are applicable to machines equipped with 29.5R25 - ** Bridgestone radial tires at 75 psi cold inflation pressure.
3. Capacities appearing above the bold line are based on structural strength and tipping should not be relied upon as a capacity limitation.
4. Capacities are applicable only with machine on firm level surface.
5. On tire lifting with the boom extensions is not permitted.
6. For pick and carry operation, boom must be centered over the front of the machine with the swing lock engaged and the load restrained from swinging.
7. Axle lockouts must be functioning when lifting on tires.
8. All lifting depends on proper tire inflation, capacity and condition. Capacities must be reduced for lower tire inflation pressures. See lifting capacity information for tire used. Damaged tires are hazardous to safe operation of crane.

SRC865XL - LOAD STATIONARY, OVER FRONT TIRES, 360°

Stationary On Tires  Over Front Tires 				
RADIUS FT	Boom Length - Feet			
	37.7	50.5	63.2	88.6
10	47050 (70)	46500 (75.5)	39220* (78)	
12	40360 (66.5)	39810 (73.5)	33540 (77)	
15	32680 (61.5)	32130 (69.5)	27020 (74.5)	28860 * (78)
20	23980 (51.5)	23440 (63)	23100 (69.5)	21450 (76.5)
25	18160 (39.5)	17610 (56)	17270 (64.5)	16490 (73)
30	13770 (20.5)	12900 (48.5)	12590 (59)	14910 (69.5)
35		9110 (39.5)	8810 (53)	10980 (66)
40			6150 (47)	8220 (62)
45			4210 (39.5)	6200 (58.5)
50			2720 (31)	4650 (54)
55				3380 (50)
60				2350 (45)
65				1510 (40)
MIN BOOM ANGLE	0°	0°	0°	37°
PARTS LINE	6	6	6	6

Boom Angle	Main Boom Length - Feet		
	37.7	50.5	63.2
0°	12370 (31.1)	4820 (43.9)	1140 (56.6)



SRC865XL - LOAD PICK & CARRY ON TIRES

Pick & Carry On Tires  Over Front Tires 				
RADIUS FT	Boom Length - Feet			
	37.7	50.5	63.2	88.6
10	41970 (70)	41390 (75.5)	34870* (78)	
12	35800 (66.5)	35230 (73.5)	29640 (77)	
15	28720 (61.5)	28160 (69.5)	23630 (74.5)	25550 * (78)
20	20710 (51.5)	20150 (63)	19790 (69.5)	18720 (76.5)
25	15340 (39.5)	14780 (56)	14420 (64.5)	14140 (73)
30	11770 (20.5)	10940 (48.5)	10590 (59)	12790 (69.5)
35		8069 (39.5)	7700 (53)	9900 (66)
40			5450 (47)	7630 (62)
45			3660 (39.5)	5830 (58.5)
50			2200 (31)	4360 (54)
55				3110 (50)
60				2040 (45)
65				1140 (40)
MIN BOOM ANGLE	0°	0°	20°	37°
PARTS LINE	6	6	6	6

Boom Angle	Main Boom Length - Feet	
	37.7	50.5
0°	10780 (31.1)	4360 (43.9)

Number in parentheses () is the Boom Angle in Degrees.

* This rated load is with the boom at the maximum boom angle.

SRC865 - BOOM EXTENSION, ON OUTRIGGERS - FULLY EXTENDED, 360°												
		 Boom Extension		 Outriggers Fully Extended				 360°				
Radius Feet	30.2 Feet						52.5 Feet					
	Offset Angle						Offset Angle					
	0°		15°		30°		0°		15°		30°	
	Lbs	Deg	Lbs	Deg	Lbs	Deg	Lbs	Deg	Lbs	Deg	Lbs	Deg
35	10090	78										
40	9630	77										
45	9230	75	8020	77			6410	78				
50	8590	73.5	7600	75	6810	77.5	6080	76				
55	8090	71.5	7160	73.5	6500	75.5	5950	75	4710	77.5		
60	7420	70	6610	72	6100	73.5	5680	73	4650	76		
65	6790	68	6170	70	5700	71.5	5420	71.5	4340	74.5	3240	78
70	6190	66	5660	68.5	5290	70	4910	69.5	4030	73	3240	76
75	5640	64	5260	66	4930	67.5	4450	68	3760	71	3210	74
80	5240	62.5	4850	65	4650	66	4120	66.5	3480	70	3130	73
85	4850	60.5	4430	62	4340	64	3790	64.5	3260	68	2990	71
90	4470	58.5	4100	60	4010	62.5	3430	63	3060	66	2860	69.5
95	4120	56	3850	58.5	3740	60	3150	61.5	2910	65	2710	67.5
100	3760	54	3520	56	3460	57.5	2880	59.5	2750	63	2550	65.5
105	3300	52	3190	54	3080	55	2680	58	2550	61	2460	64.5
110	2750	49.5	2860	51.5	2750	53.5	2490	56	2350	60	2310	62
115	1960	47	2420	49	2420	51.5	2200	54.5	2200	58	2130	60.5
120	1490	44.5	1850	46.5	2050	49	1980	52.5	2050	56	1980	59
125	1050	42	1380	44	1540	46	1650	50	1870	54	1800	56.5
130	680	39	940	41	1100	43	1320	48	1690	52	1650	54.5
135			550	39	660	39.5	1050	45.5	1540	50	1430	51.5
140							700	44	1320	47.5	1210	49.5
145									1100	46	880	47
150									770	43	630	45
Min Boom Angle No Load	39°		39°		39.5°		44°		43°		45°	

* This rated load is with the boom at the maximum boom angle.

WARNING: Operation of this machine with heavier loads than the capacities listed is strictly prohibited. Machine tipping with boom extension occurs rapidly and without advance warning.

1. Capacities above the bold line are based on the structural strength of the boom extension.
2. The capacities listed are with the outriggers fully extended and vertical jacks properly set only.
3. The boom extension may only be used for single line lifting service.
4. Use only the load which corresponds to the boom extension length and offset angle as the machine is configured.
5. For main boom lengths less than fully extended with the boom extension erected, the boom extension rated loads are determined by the boom angle not the radius.
6. For boom angles not shown, use the rating of the next lower boom angle.
7. The boom angle is defined as the angle above or below the horizontal line of the longitudinal axis of the boom base section after lifting the rated load.
8. When lifting over the main boom nose with the boom extension erected, the outriggers must be fully extended and the proper load reduction must be used.
9. Do not lower the boom below the Minimum Boom Angle with the extension erected. Fully retract the boom to lower the boom below the Minimum Boom Angle.



SANY
AMERICA INC.



Please visit www.sanyamerica.com to find out more.

318 Cooper Circle South | Peachtree City, GA 30269 | Tel: 678-251-2810 | Fax: 770-631-7731

*We are constantly improving our products and therefore reserve the right to change designs and specifications.

www.sanyamerica.com